

This draft drawing has been supplied by Euroclad Group Ltd for the purpose of guidance free of charge. It is a suggested typical detail and as such should not be assumed suitable for any specific project or application. No responsibility is assumed for errors or misinterpretations resulting from the information contained in the drawing. Details are for illustration only and no liability is accepted. We reserve the right to change the details without notice. The drawing is copyright, it remains our property.

To be read in conjunction with Elite System specification documents

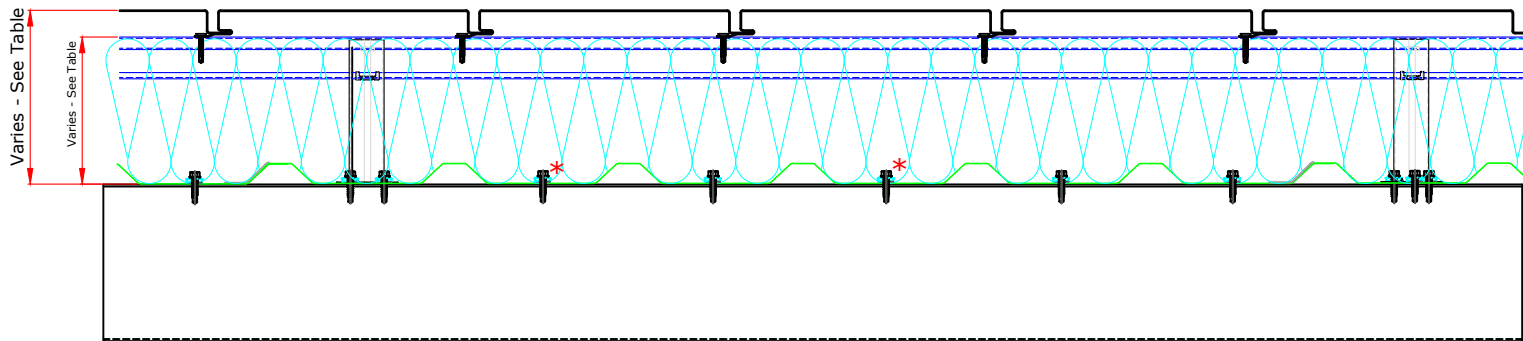

*Fixings with an asterisk are required on sheet ends and end laps only.

Elite System 54

Bracket Height	Insulation Thickness	Insulation Value	Overall System Depth	U Value at 1.8M Centres
120mm	120mm	0.040	145mm	0.35
140mm	140mm	0.040	165mm	0.30
150mm	150mm*/160mm	0.040	175mm	0.28
160mm	160mm	0.040	185mm	0.27
170mm	180mm	0.040	195mm	0.25
180mm	180mm	0.040	205mm	0.24
200mm	200mm	0.040	225mm	0.21
220mm	220mm	0.040	245mm	0.20
240mm	240mm	0.040	265mm	0.18
260mm	260mm	0.040	285mm	0.17
280mm	280mm	0.040	305mm	0.15
300mm	300mm	0.040	325mm	0.14

* Only available in Rockwool Cladding Roll

Please Note:

System is fire rated using Knauf Factoryclad 40 ECOSE insulation of minimum thickness 80mm with steel outer sheet only, to achieve 120 minutes Integrity, 15 minutes (min) Insulation which meets the requirements of Building Regulations Part B for external walls where fire attack is from inside the building and the wall is 1M or more from the boundary.

System can be fire rated using Rockwool insulation of minimum thickness 120mm with steel outer sheet only, with liner stitched at 300mm centres, to achieve 120 minutes Integrity, 30 minutes (min) Insulation.

Ensure roll edges are lapped/butted to ensure no gaps.

Please Note:
WT75 Self Adhesive Barrier Tape must be used on Quattro rails when aluminium Opus is being used.

Please Note:
System is fire rated using Knauf Factoryclad 40 ECOSE insulation of minimum thickness 80mm with steel outer sheet only, to achieve 120 minutes Integrity, 15 minutes (min) Insulation which meets the requirements of Building Regulations Part B for external walls where fire attack is from inside the building and the wall is 1M or more from the boundary.

System can be fire rated using Rockwool insulation of minimum thickness 120mm with steel outer sheet only, with liner stitched at 300mm centres, to achieve 120 minutes Integrity, 30 minutes (min) Insulation.

Ensure roll edges are lapped/butted to ensure no gaps.

ELITE SYSTEM 54 VERTICAL JOINT DETAIL

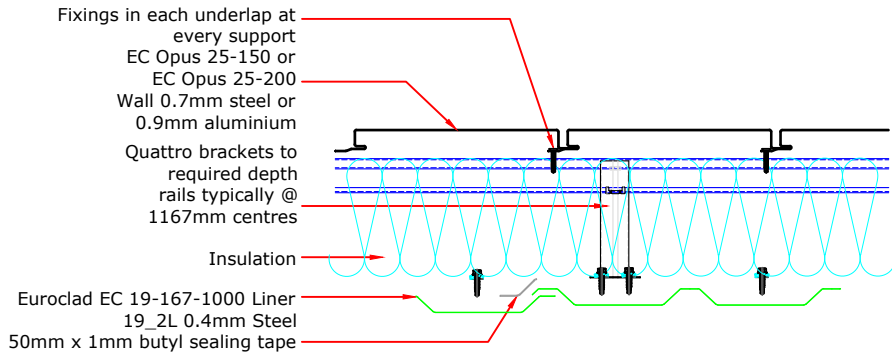

ELITE SYSTEM 54 HORIZONTAL JOINT DETAIL

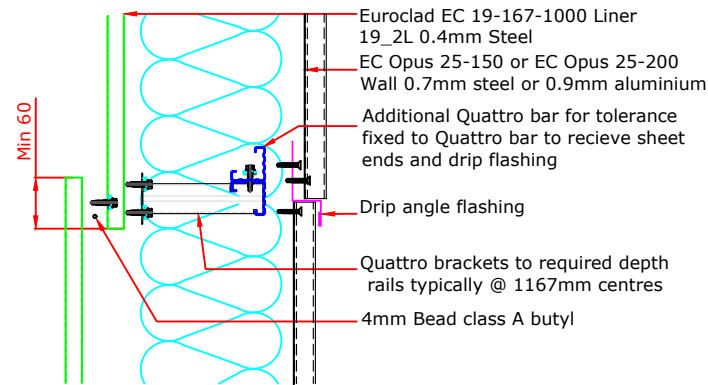

NB: Drip flashing to 2nd Quattro bar @ 450mm centres
Fixing to avoid panel side lap positions

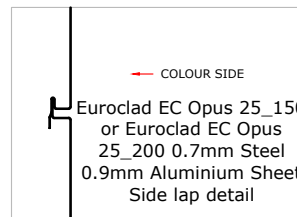
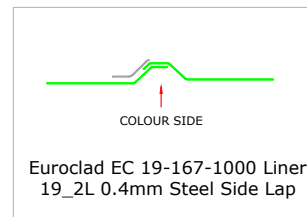

ELITE SYSTEMS

EUROCLAD

www.euroclad.com
Tel: +44 (0)2922 010 101
Fax: +44 (0)2922 010 122

TITLE: Elite System 54
DWG NO: E54
DRAWN: CD
CHECK: MP
DATE: Jan 2020
SCALE: NTS

This draft drawing has been supplied by Euroclad Group Ltd for the purpose of guidance free of charge. It is a suggested typical detail and as such should not be assumed suitable for any specific project or application. No responsibility is assumed for errors or misinterpretations resulting from the information contained in the drawing. Details are for illustration only and no liability is accepted. We reserve the right to change the details without notice. The drawing is copyright, it remains our property.

To be read in conjunction with Elite System specification documents

EUROCLAD EC OPUS 25-150 and EC OPUS 25-200 0.7mm Steel 0.9mm Aluminium EXTERNAL SHEET

NB: Module = Face + Gap size
Gap size should be kept uniform with the use of packers

Plank 150mm Module

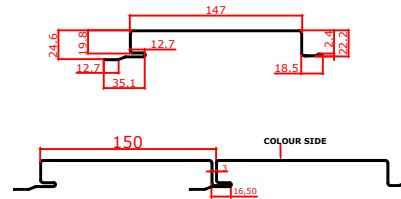

Plank 200mm Module

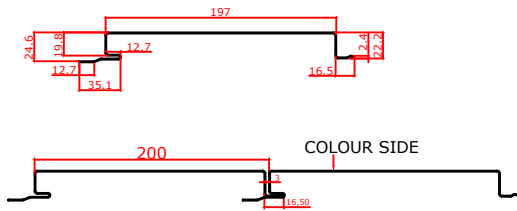

3mm Gap

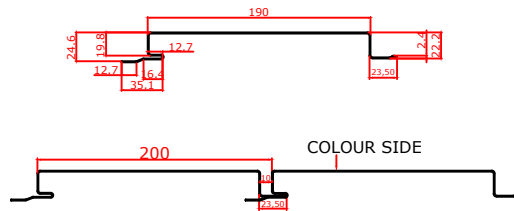

10mm Gap

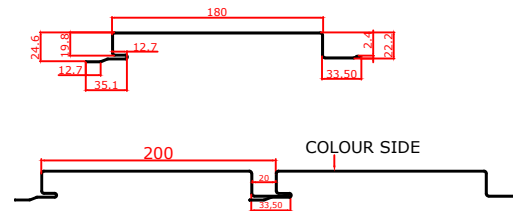

20mm Gap

EUROCLAD EC 19-167-1000 Liner 19_2L 0.4mm Steel LINER

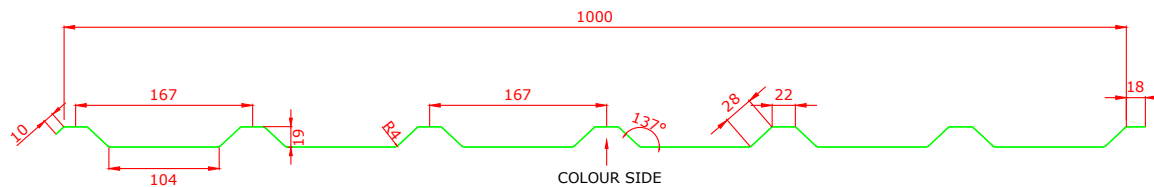

ELITE SYSTEMS

EUROCLAD

www.euroclad.com
 Tel: +44 (0)2922 010 101
 Fax: +44 (0)2922 010 122

TITLE: Elite System 54

DWG NO: E54

DRAWN: CD

CHECK: MP

DATE: Jan 2020

SCALE: NTS

This draft drawing has been supplied by Euroclad Group Ltd for the purpose of guidance free of charge. It is a suggested typical detail and as such should not be assumed suitable for any specific project or application. No responsibility is assumed for errors or misinterpretations resulting from the information contained in the drawing. Details are for illustration only and no liability is accepted. We reserve the right to change the details without notice. The drawing is copyright, it remains our property.

To be read in conjunction with Elite System specification documents

This draft drawing has been supplied by Euroclad Group Ltd for the purpose of guidance free of charge. It is a suggested typical detail and as such should not be assumed suitable for any specific project or application. No responsibility is assumed for errors or misinterpretations resulting from the information contained in the drawing. Details are for illustration only and no liability is accepted. We reserve the right to change the details without notice. The drawing is copyright, it remains our property.

To be read in conjunction with Elite System specification documents

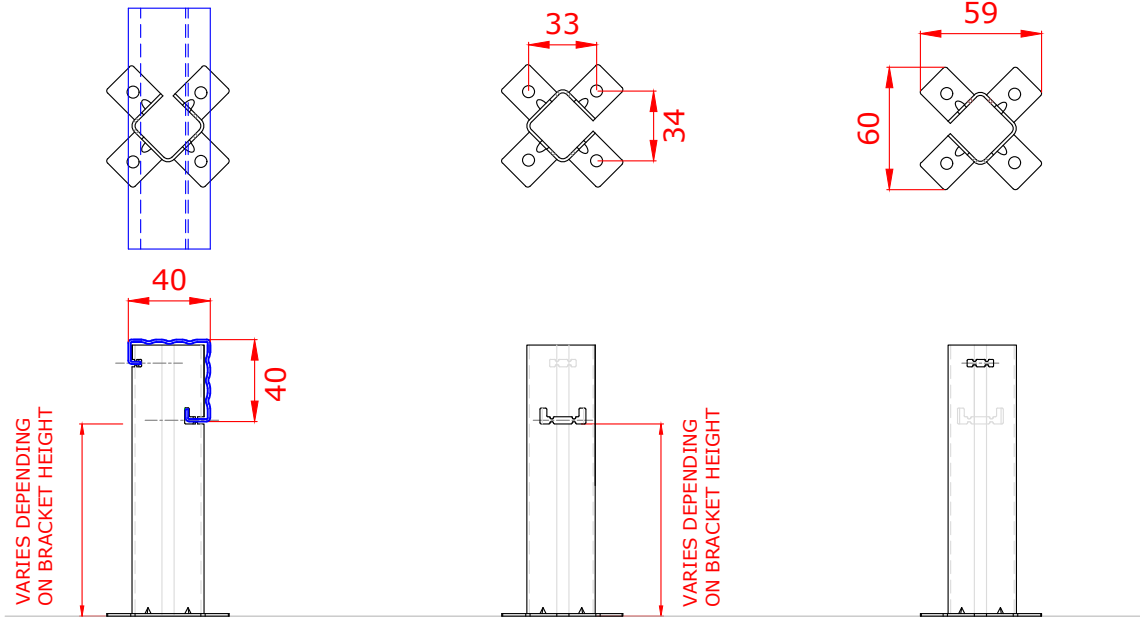
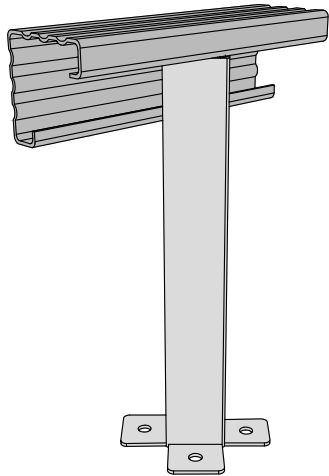

Brackets less than 260mm require 2 fixings diagonally opposite.
Brackets 260mm or more require 4 fixings.

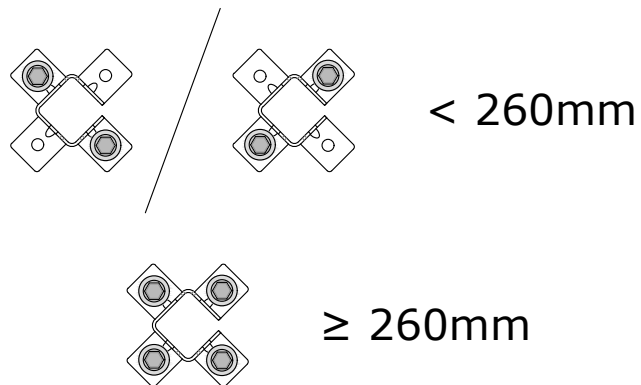

Maximum bar cantilever at free ends is 300mm.
Spigot can fall anywhere between two brackets.

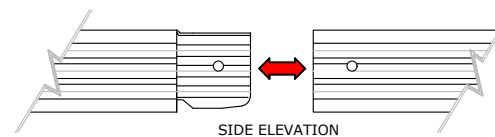

ELITE SYSTEMS



www.euroclad.com
 Tel: +44 (0)2922 010 101
 Fax: +44 (0)2922 010 122

TITLE: Elite System 54
 DWG NO: E54
 DRAWN: CD
 CHECK: MP
 DATE: Jan 2020
 SCALE: NTS

This draft drawing has been supplied by Euroclad Group Ltd for the purpose of guidance free of charge. It is a suggested typical detail and as such should not be assumed suitable for any specific project or application. No responsibility is assumed for errors or misinterpretations resulting from the information contained in the drawing. Details are for illustration only and no liability is accepted. We reserve the right to change the details without notice. The drawing is copyright, it remains our property.

To be read in conjunction with Elite System specification documents

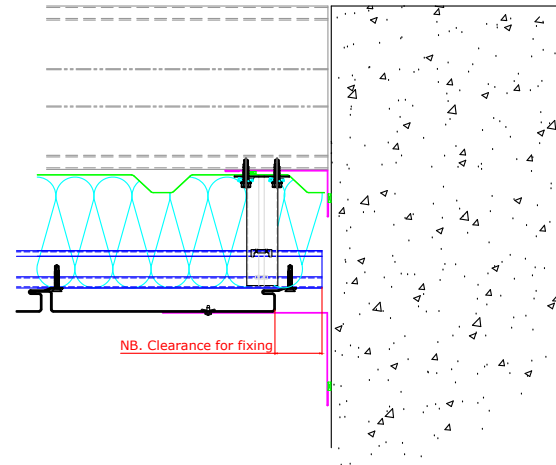

EUROCLAD ELITE SYSTEM 54 WALL CONSTRUCTION

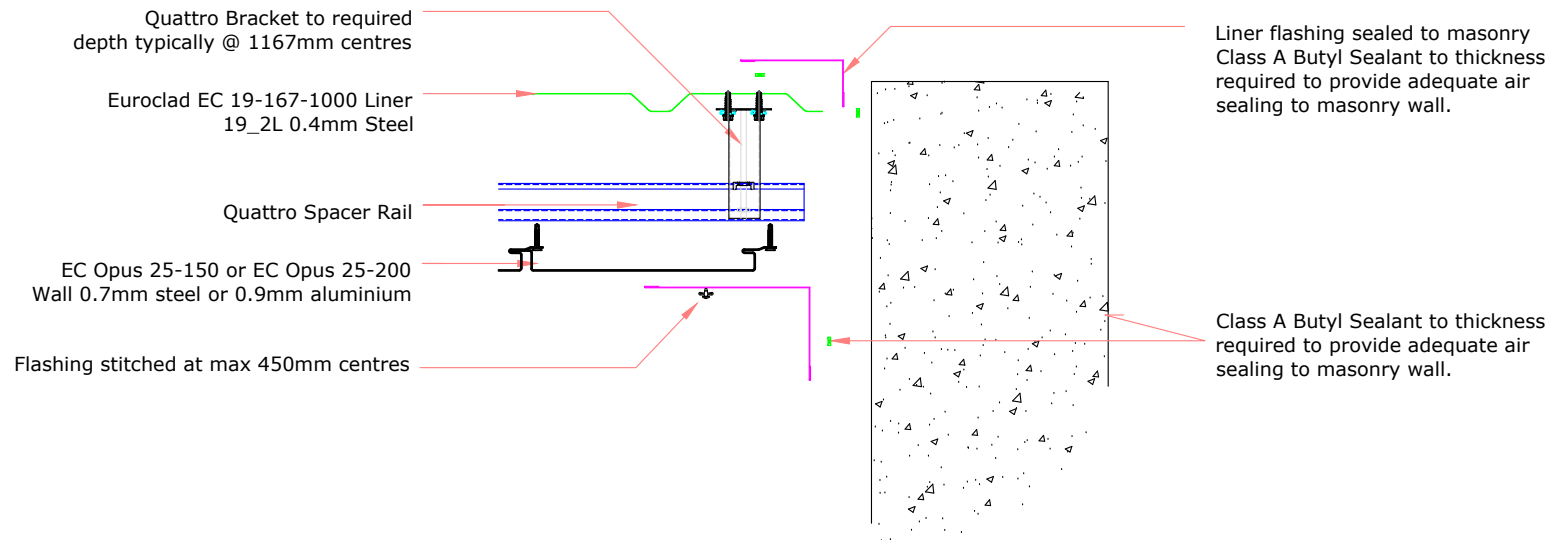

Insulation excluded for clarity
 A range of mineral & glass wool insulations are available for different requirements

ELITE SYSTEMS



www.euroclad.com
 Tel: +44 (0)2922 010 101
 Fax: +44 (0)2922 010 122

TITLE: Elite System 54
 DWG NO: E54
 DRAWN: CD
 CHECK: MP
 DATE: Jan 2020
 SCALE: NTS

This draft drawing has been supplied by Euroclad Group Ltd for the purpose of guidance free of charge. It is a suggested typical detail and as such should not be assumed suitable for any specific project or application. No responsibility is assumed for errors or misinterpretations resulting from the information contained in the drawing. Details are for illustration only and no liability is accepted. We reserve the right to change the details without notice. The drawing is copyright, it remains our property.

To be read in conjunction with Elite System specification documents

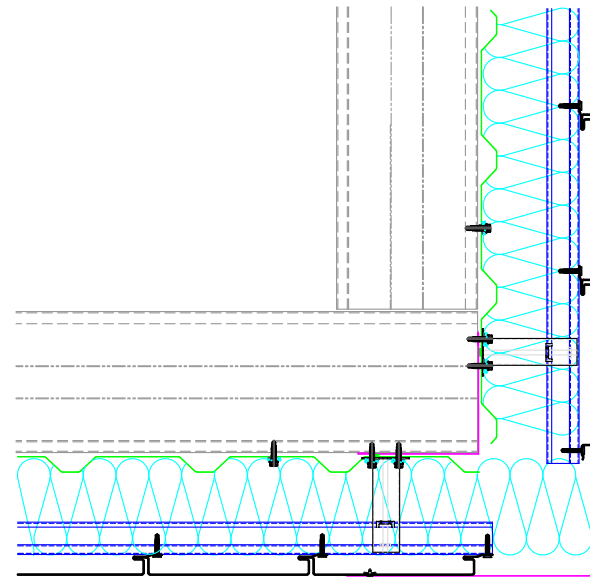

EUROCLAD ELITE SYSTEM 54 WALL CONSTRUCTION

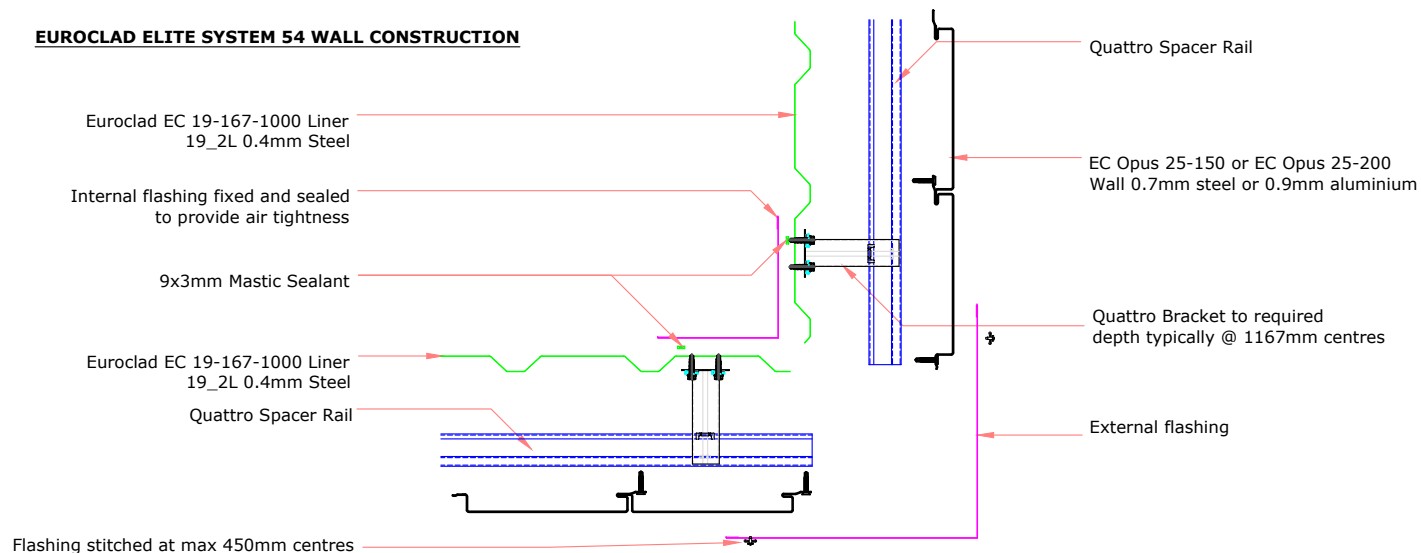

Insulation excluded for clarity
 A range of mineral & glass wool insulations are available for different requirements

ELITE SYSTEMS



www.euroclad.com
 Tel: +44 (0)2922 010 101
 Fax: +44 (0)2922 010 122

TITLE: Elite System 54
 DWG NO: E54
 DRAWN: CD
 CHECK: MP
 DATE: Jan 2020
 SCALE: NTS

This draft drawing has been supplied by Euroclad Group Ltd for the purpose of guidance free of charge. It is a suggested typical detail and as such should not be assumed suitable for any specific project or application. No responsibility is assumed for errors or misinterpretations resulting from the information contained in the drawing. Details are for illustration only and no liability is accepted. We reserve the right to change the details without notice. The drawing is copyright, it remains our property.

To be read in conjunction with Elite System specification documents

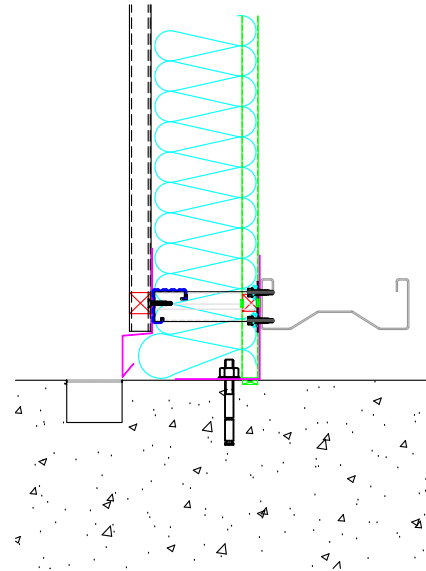

EUROCLAD ELITE SYSTEM 54 WALL CONSTRUCTION

EC Opus 25-150 or EC Opus 25-200
 Wall 0.7mm steel or 0.9mm aluminium

Quattro Bracket to required
 depth typically @ 1167mm centres

Profile Filler

Drip Flashing

Drainage Point

Euroclad EC 19-167-1000 Liner
 19_2L 0.4mm Steel

Internal Flashing and profile filler sealed to liner

Large amount of sealant to make allowance for imperfection in concrete and ensure good airtightness. Seal may be achieved at flashing or structural element such as ring beam, depending on project specific details.

Insulation excluded for clarity

A range of mineral & glass wool insulations are available for different requirements

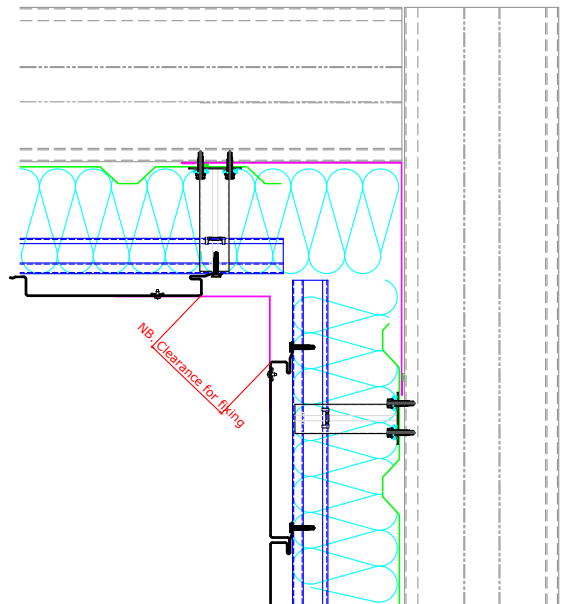

ELITE SYSTEMS



www.euroclad.com
 Tel: +44 (0)2922 010 101
 Fax: +44 (0)2922 010 122

TITLE: Elite System 54
 DWG NO: E54
 DRAWN: CD
 CHECK: MP
 DATE: Jan 2020
 SCALE: NTS

This draft drawing has been supplied by Euroclad Group Ltd for the purpose of guidance free of charge. It is a suggested typical detail and as such should not be assumed suitable for any specific project or application. No responsibility is assumed for errors or misinterpretations resulting from the information contained in the drawing. Details are for illustration only and no liability is accepted. We reserve the right to change the details without notice. The drawing is copyright, it remains our property.

To be read in conjunction with Elite System specification documents

EUROCLAD ELITE SYSTEM 54 WALL CONSTRUCTION

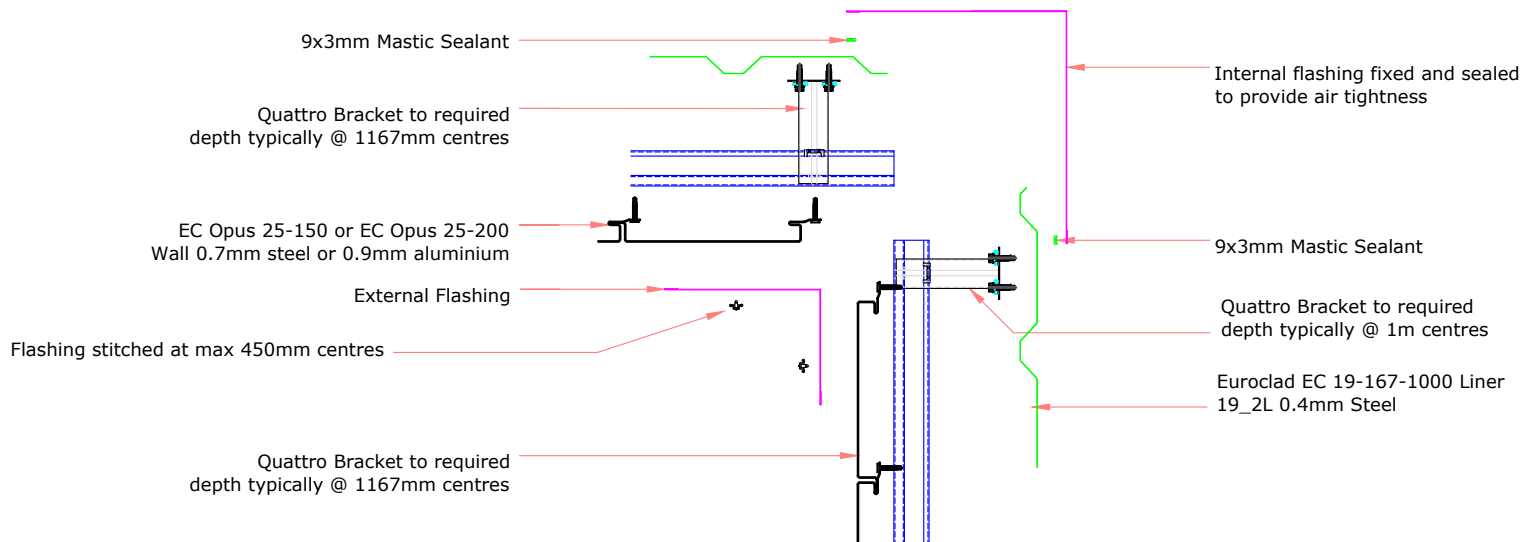

Insulation excluded for clarity
 A range of mineral & glass wool insulations are available for different requirements

ELITE SYSTEMS



www.euroclad.com
 Tel: +44 (0)2922 010 101
 Fax: +44 (0)2922 010 122

TITLE: Elite System 54
 DWG NO: E54
 DRAWN: CD
 CHECK: MP
 DATE: Jan 2020
 SCALE: NTS

This draft drawing has been supplied by Euroclad Group Ltd for the purpose of guidance free of charge. It is a suggested typical detail and as such should not be assumed suitable for any specific project or application. No responsibility is assumed for errors or misinterpretations resulting from the information contained in the drawing. Details are for illustration only and no liability is accepted. We reserve the right to change the details without notice. The drawing is copyright, it remains our property.

To be read in conjunction with Elite System specification documents

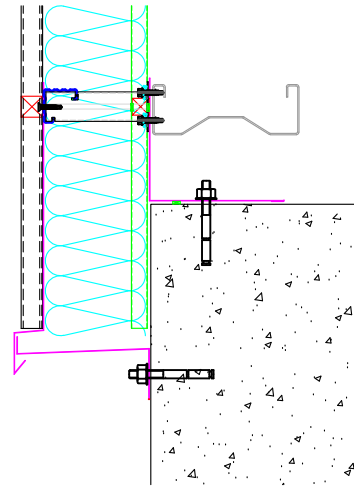

EUROCLAD ELITE SYSTEM 54 WALL CONSTRUCTION

EC Opus 25-150 or EC Opus 25-200
 Wall 0.7mm steel or 0.9mm aluminium

Euroclad EC 19-167-1000 Liner
 19_2L 0.4mm Steel

Profile Filler

Quattro Bracket to required
 depth typically @ 1167mm centres

Drip Flashing

Closure Flashing

Liner Flashing fillers fixed and sealed to liners to provide air tightness and vapour control

Large amount of sealant to make allowance for imperfection in concrete and ensure good airtightness. Seal may be achieved at flashing or structural element such as ring beam, depending on project specific details.

Insulation excluded for clarity
 A range of mineral & glass wool insulations are available for different requirements

ELITE SYSTEMS



www.euroclad.com
 Tel: +44 (0)2922 010 101
 Fax: +44 (0)2922 010 122

TITLE: Elite System 54
 DWG NO: E54
 DRAWN: CD
 CHECK: MP
 DATE: Jan 2020
 SCALE: NTS

This draft drawing has been supplied by Euroclad Group Ltd for the purpose of guidance free of charge. It is a suggested typical detail and as such should not be assumed suitable for any specific project or application. No responsibility is assumed for errors or misinterpretations resulting from the information contained in the drawing. Details are for illustration only and no liability is accepted. We reserve the right to change the details without notice. The drawing is copyright, it remains our property.

To be read in conjunction with Elite System specification documents

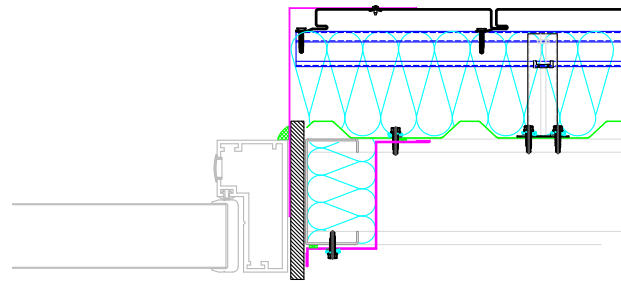

EUROCLAD ELITE SYSTEM 54 WALL CONSTRUCTION

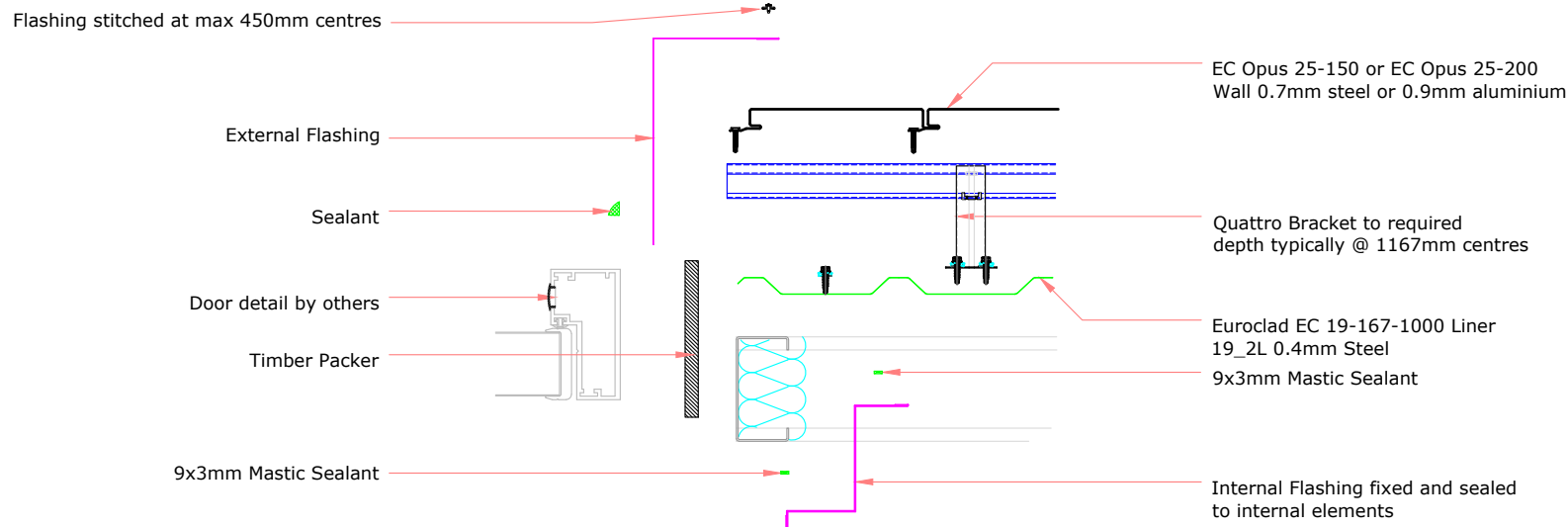

Insulation excluded for clarity
 A range of mineral & glass wool insulations are available for different requirements

ELITE SYSTEMS



www.euroclad.com
 Tel: +44 (0)2922 010 101
 Fax: +44 (0)2922 010 122

TITLE: Elite System 54
 DWG NO: E54
 DRAWN: CD
 CHECK: MP
 DATE: Jan 2020
 SCALE: NTS

This draft drawing has been supplied by Euroclad Group Ltd for the purpose of guidance free of charge. It is a suggested typical detail and as such should not be assumed suitable for any specific project or application. No responsibility is assumed for errors or misinterpretations resulting from the information contained in the drawing. Details are for illustration only and no liability is accepted. We reserve the right to change the details without notice. The drawing is copyright, it remains our property.

To be read in conjunction with Elite System specification documents

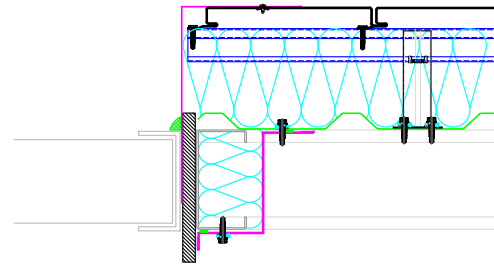

EUROCLAD ELITE SYSTEM 54 WALL CONSTRUCTION

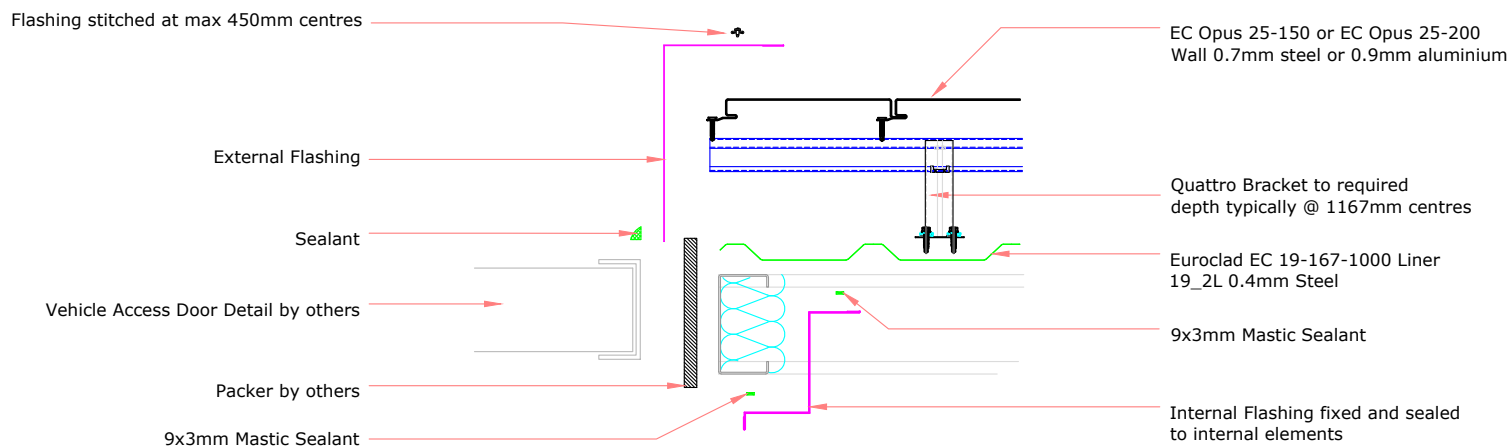

ELITE SYSTEMS



www.euroclad.com
 Tel: +44 (0)2922 010 101
 Fax: +44 (0)2922 010 122

TITLE: Elite System 54
 DWG NO: E54
 DRAWN: CD
 CHECK: MP
 DATE: Jan 2020
 SCALE: NTS

This draft drawing has been supplied by Euroclad Group Ltd for the purpose of guidance free of charge. It is a suggested typical detail and as such should not be assumed suitable for any specific project or application. No responsibility is assumed for errors or misinterpretations resulting from the information contained in the drawing. Details are for illustration only and no liability is accepted. We reserve the right to change the details without notice. The drawing is copyright, it remains our property.

To be read in conjunction with Elite System specification documents

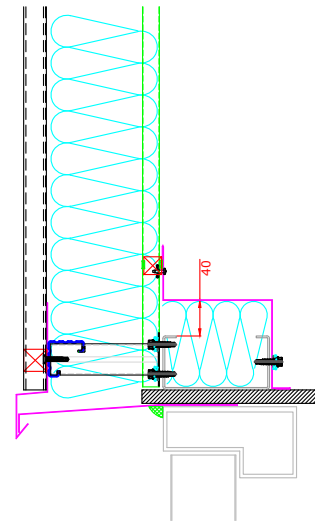

EUROCLAD ELITE SYSTEM 54 WALL CONSTRUCTION

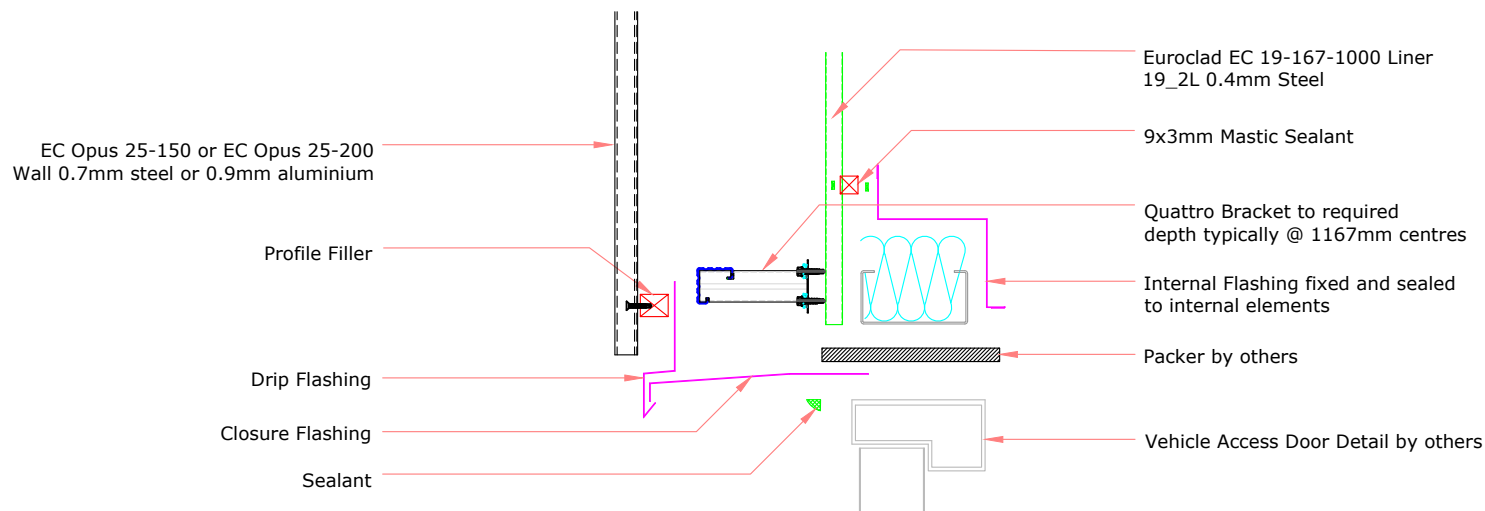

Insulation excluded for clarity
 A range of mineral & glass wool insulations are available for different requirements

ELITE SYSTEMS



www.euroclad.com
 Tel: +44 (0)2922 010 101
 Fax: +44 (0)2922 010 122

TITLE: Elite System 54
 DWG NO: E54
 DRAWN: CD
 CHECK: MP
 DATE: Jan 2020
 SCALE: NTS

This draft drawing has been supplied by Euroclad Group Ltd for the purpose of guidance free of charge. It is a suggested typical detail and as such should not be assumed suitable for any specific project or application. No responsibility is assumed for errors or misinterpretations resulting from the information contained in the drawing. Details are for illustration only and no liability is accepted. We reserve the right to change the details without notice. The drawing is copyright, it remains our property.

To be read in conjunction with Elite System specification documents

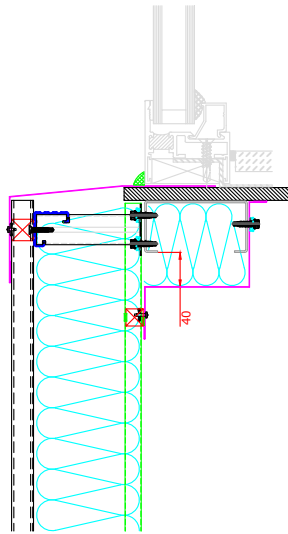

EUROCLAD ELITE SYSTEM 54 WALL CONSTRUCTION

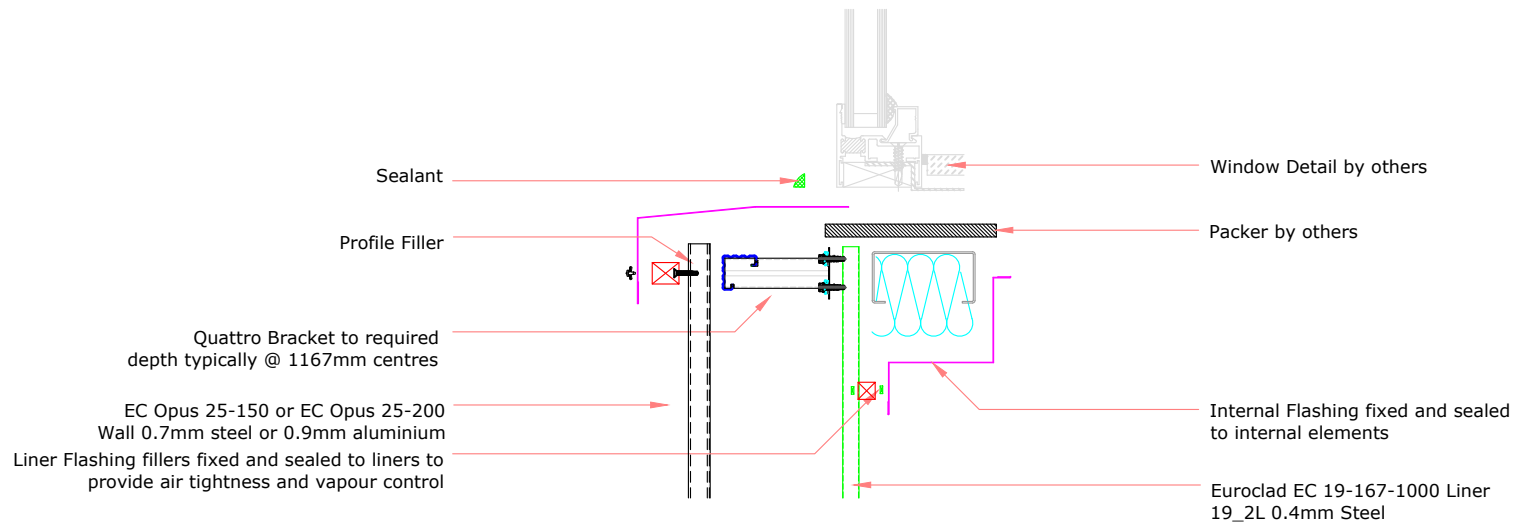

Insulation excluded for clarity
 A range of mineral & glass wool insulations are available for different requirements

ELITE SYSTEMS



www.euroclad.com
 Tel: +44 (0)2922 010 101
 Fax: +44 (0)2922 010 122

TITLE: Elite System 54
 DWG NO: E54
 DRAWN: CD
 CHECK: MP
 DATE: Jan 2020
 SCALE: NTS

This draft drawing has been supplied by Euroclad Group Ltd for the purpose of guidance free of charge. It is a suggested typical detail and as such should not be assumed suitable for any specific project or application. No responsibility is assumed for errors or misinterpretations resulting from the information contained in the drawing. Details are for illustration only and no liability is accepted. We reserve the right to change the details without notice. The drawing is copyright, it remains our property.

To be read in conjunction with Elite System specification documents

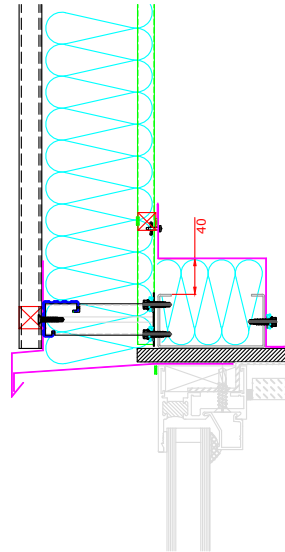

EUROCLAD ELITE SYSTEM 54 WALL CONSTRUCTION

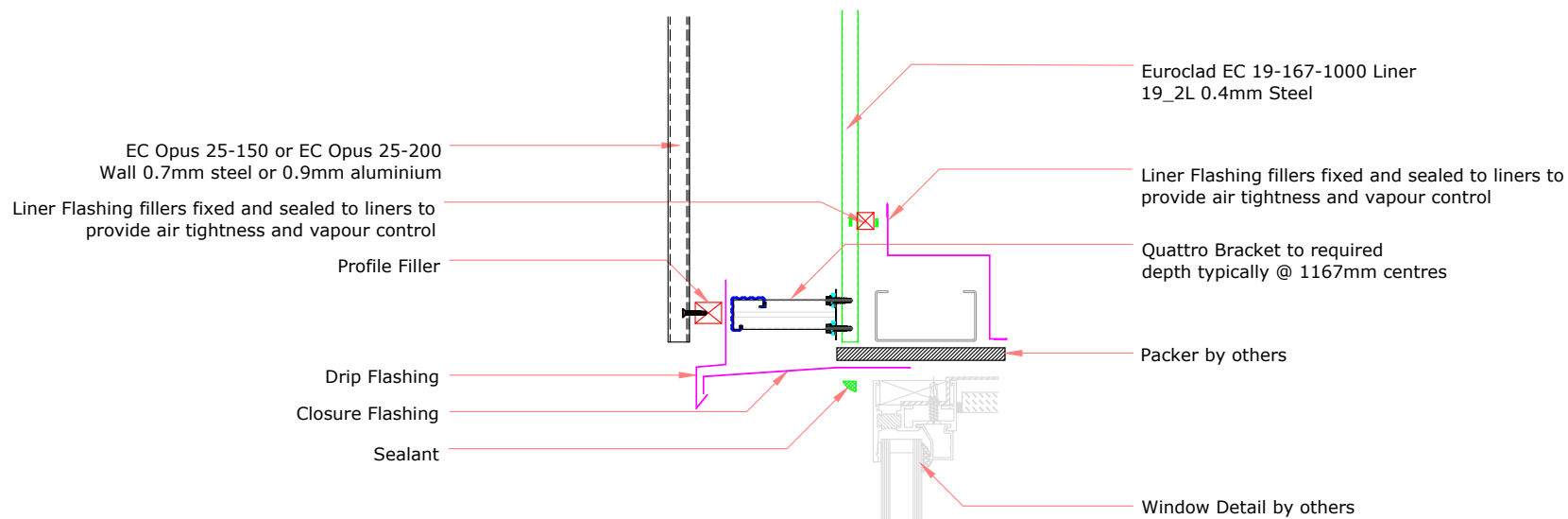

Insulation excluded for clarity
 A range of mineral & glass wool insulations are available for different requirements

ELITE SYSTEMS



www.euroclad.com
 Tel: +44 (0)2922 010 101
 Fax: +44 (0)2922 010 122

TITLE: Elite System 54
 DWG NO: E54
 DRAWN: CD
 CHECK: MP
 DATE: Jan 2020
 SCALE: NTS

This draft drawing has been supplied by Euroclad Group Ltd for the purpose of guidance free of charge. It is a suggested typical detail and as such should not be assumed suitable for any specific project or application. No responsibility is assumed for errors or misinterpretations resulting from the information contained in the drawing. Details are for illustration only and no liability is accepted. We reserve the right to change the details without notice. The drawing is copyright, it remains our property.

To be read in conjunction with Elite System specification documents

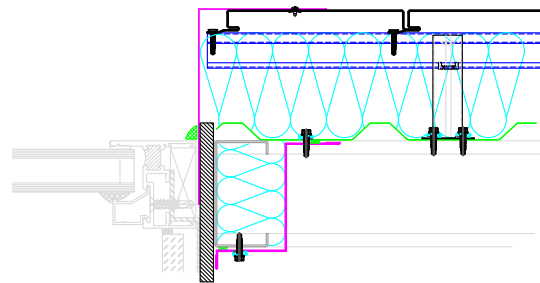

EUROCLAD ELITE SYSTEM 54 WALL CONSTRUCTION

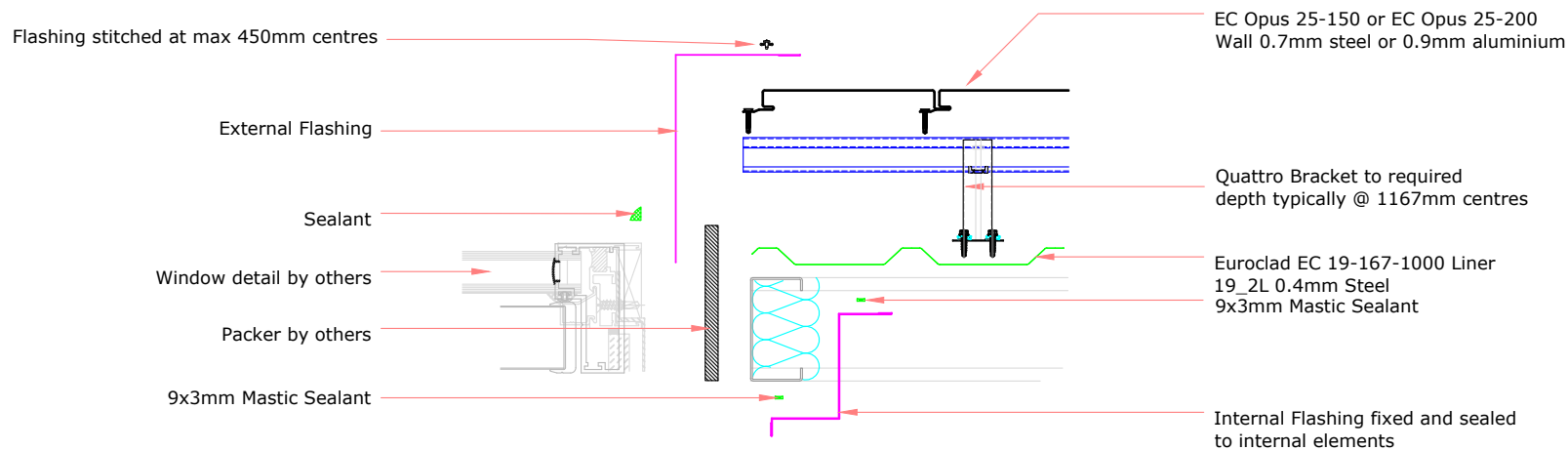

Insulation excluded for clarity

A range of mineral & glass wool insulations are available for different requirements