

ELITE SYSTEMS

**EUROCLAD**

www.euroclad.com  
Tel: +44 (0)2922 010 101  
Fax: +44 (0)2922 010 122

TITLE: Elite System 57  
DWG NO: E57  
DRAWN: MP  
CHECK: PCL  
DATE: August 2015  
SCALE: NTS

This draft drawing has been supplied by Euro Clad Ltd for the purpose of guidance free of charge. It is a suggested typical detail and as such should not be assumed suitable for any specific project or application. No responsibility is assumed for errors or misinterpretations resulting from the information contained in the drawing. Details are for illustration only and no liability is accepted. We reserve the right to change the details without notice. The drawing is copyright, it remains our property.

To be read in conjunction with Elite System specification documents

### Elite System 57

Bracket Height	Insulation Thickness	Insulation Value	Overall System Depth	U Value at 1.5M Centres
100mm	100mm	0.040	120mm	0.45
120mm	120mm	0.040	140mm	0.37
140mm	140mm	0.040	160mm	0.32
160mm	160mm	0.040	180mm	0.28
180mm	180mm	0.040	200mm	0.25
200mm	200mm	0.040	220mm	0.22
220mm	220mm	0.040	240mm	0.20

**Please Note:**

System is Fire rated using Knauf Factoryclad 40 ECOSE insulation of minimum thickness 120mm with steel outer sheet only.  
Ensure roll edges are lapped/butted to ensure no gaps.  
Fire Resistance performance 120 minutes Integrity, 15 minutes (min) Insulation.  
Meets the requirements of Building Regulations Part B for external walls where fire attack is from inside the building and the wall is 1M or more from the boundary.

Please refer to the technical note: Installer guidance for quilt insulation in Elite Wall Systems  
Refer to Technical for advice on constructions requiring better U values than those shown.

**Please Note:**  
 System is Fire rated using Knauf Factoryclad 40 ECOSE insulation of minimum thickness 120mm with steel outer sheet only.  
 Ensure roll edges are lapped/butted to ensure no gaps.  
 Fire Resistance performance 120 minutes Integrity, 15 minutes (min) Insulation.  
 Meets the requirements of Building Regulations Part B for external walls where fire attack is from inside the building and the wall is 1M or more from the boundary.

ELITE SYSTEMS

**EUROCLAD**

www.euroclad.com  
 Tel: +44 (0)2922 010 101  
 Fax: +44 (0)2922 010 122

TITLE: Elite System 57  
 DWG NO: E57  
 DRAWN: MP  
 CHECK: PCL  
 DATE: August 2015  
 SCALE: NTS

This draft drawing has been supplied by Euro Clad Ltd for the purpose of guidance free of charge. It is a suggested typical detail and as such should not be assumed suitable for any specific project or application. No responsibility is assumed for errors or misinterpretations resulting from the information contained in the drawing. Details are for illustration only and no liability is accepted. We reserve the right to change the details without notice. The drawing is copyright, it remains our property.

To be read in conjunction with Elite System specification documents

ELITE SYSTEM 57 END LAP DETAIL

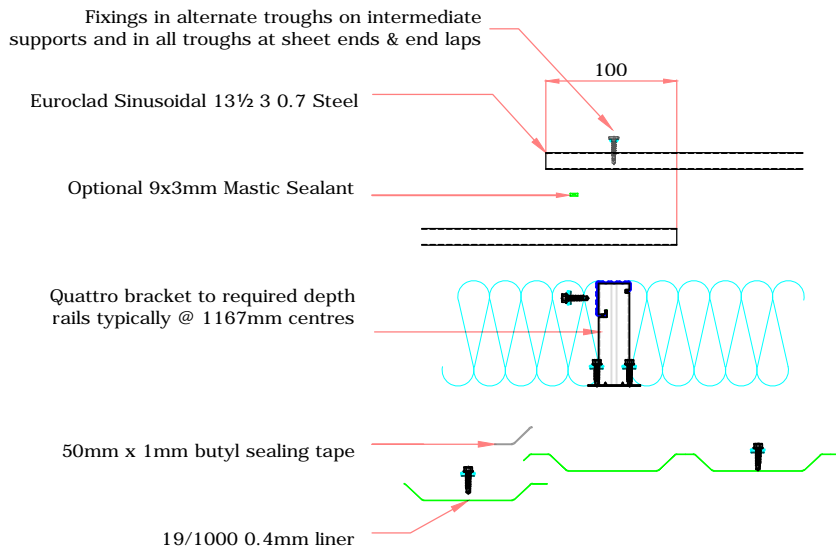

ELITE SYSTEM 57 SIDE LAP DETAIL

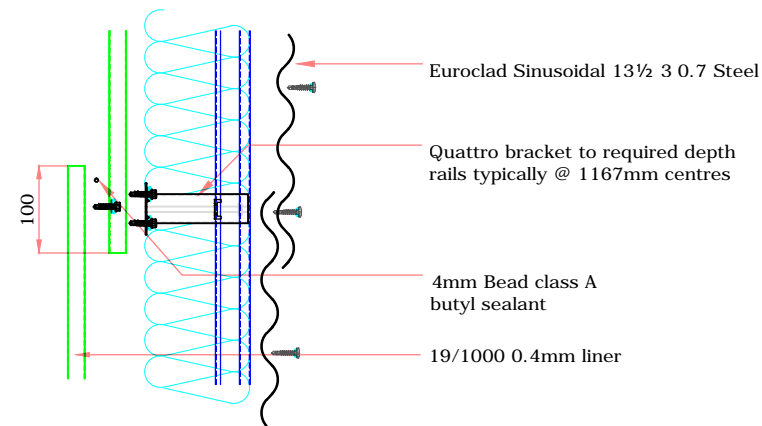

COLOUR SIDE

19\_1000\_2L 0.4 Steel  
 Liner side lap detail

COLOUR SIDE

13 1/2 3 0.7 Steel  
 Outer Sheet Side  
 lap detail

ELITE SYSTEMS

**EUROCLAD**

www.euroclad.com  
Tel: +44 (0)2922 010 101  
Fax: +44 (0)2922 010 122

TITLE: Elite System 57  
DWG NO: E57  
DRAWN: MP  
CHECK: PCL  
DATE: August 2015  
SCALE: NTS

This draft drawing has been supplied by Euro Clad Ltd for the purpose of guidance free of charge. It is a suggested typical detail and as such should not be assumed suitable for any specific project or application. No responsibility is assumed for errors or misinterpretations resulting from the information contained in the drawing. Details are for illustration only and no liability is accepted. We reserve the right to change the details without notice. The drawing is copyright, it remains our property.

To be read in conjunction with Elite System specification documents

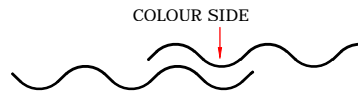

EUROCLAD 13 1/2 3 SINUSOIDAL 0.7mm EXTERNAL SHEET

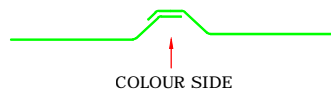
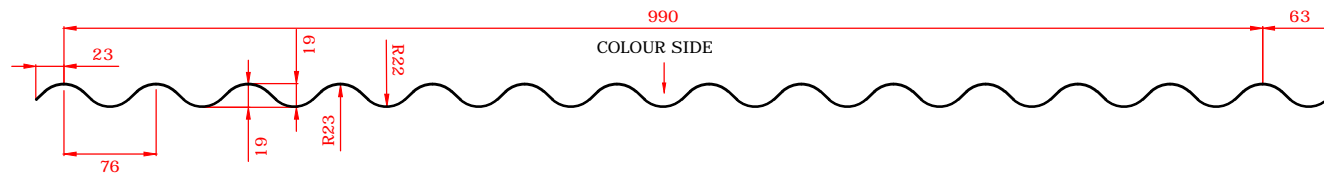

EUROCLAD 19/1000 0.4mm LINER

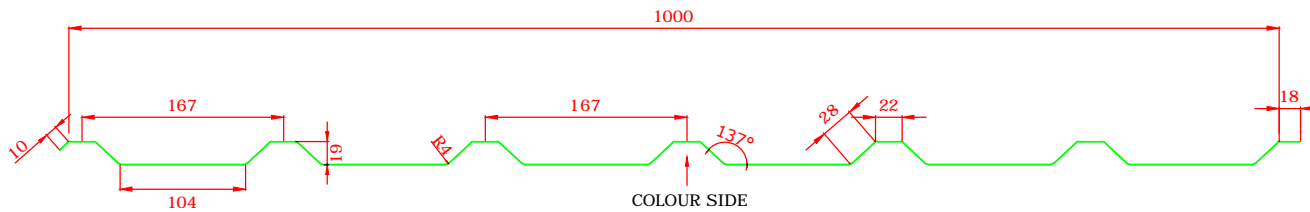

ELITE SYSTEMS

**EUROCLAD**

www.euroclad.com  
Tel: +44 (0)2922 010 101  
Fax: +44 (0)2922 010 122

TITLE: Elite System 57  
DWG NO: E57  
DRAWN: MP  
CHECK: PCL  
DATE: August 2015  
SCALE: NTS

This draft drawing has been supplied by Euro Clad Ltd for the purpose of guidance free of charge. It is a suggested typical detail and as such should not be assumed suitable for any specific project or application. No responsibility is assumed for errors or misinterpretations resulting from the information contained in the drawing. Details are for illustration only and no liability is accepted. We reserve the right to change the details without notice. The drawing is copyright, it remains our property.

To be read in conjunction with Elite System specification documents

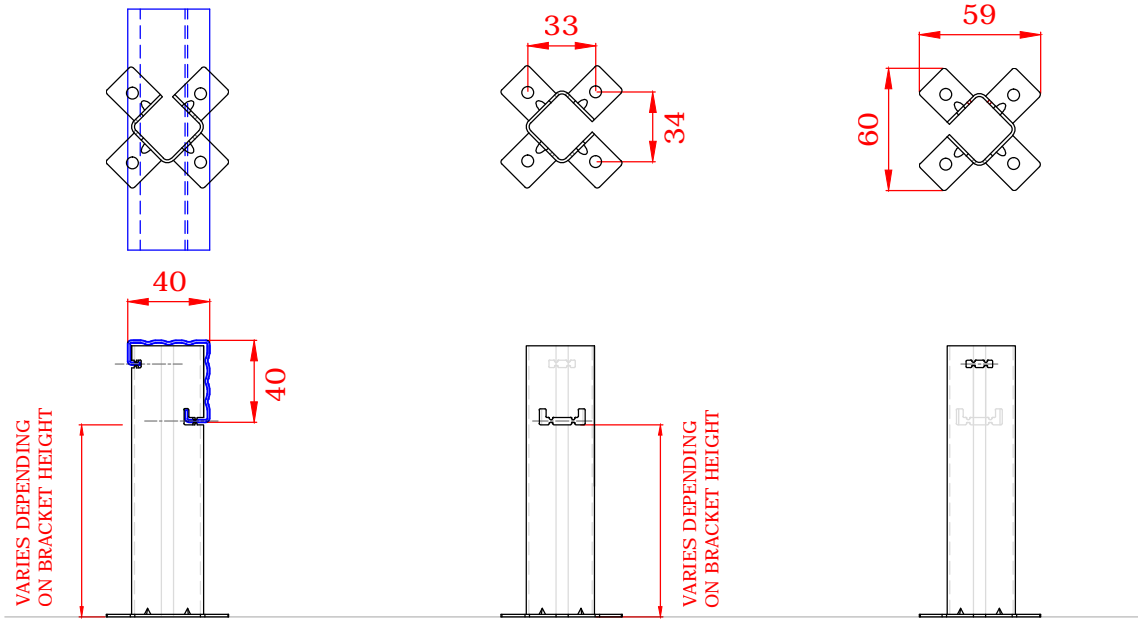
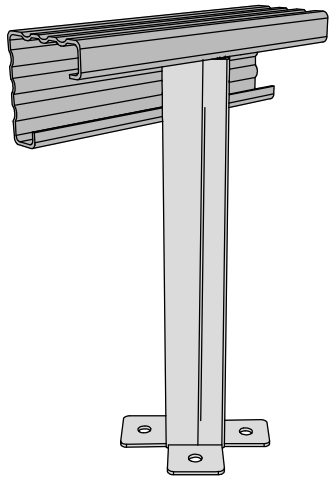

Brackets less than 260mm require 2 fixings diagonally opposite.  
Brackets 260mm or more require 4 fixings.

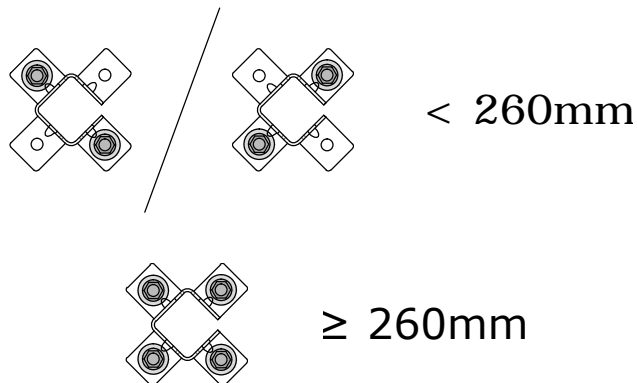

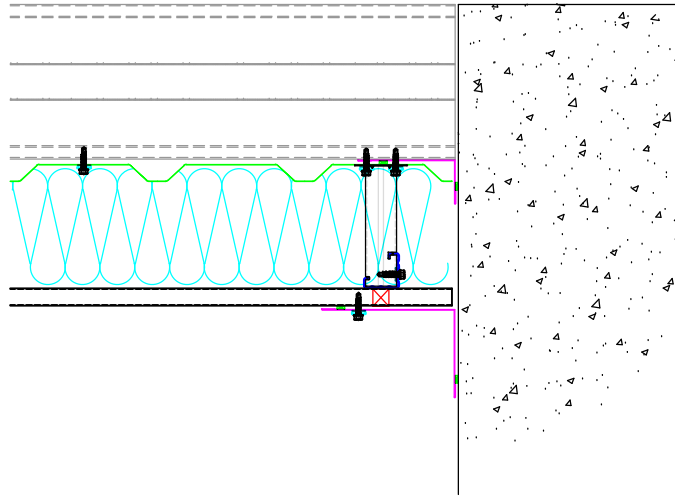

EUROCLAD ELITE SYSTEM 57 WALL CONSTRUCTION

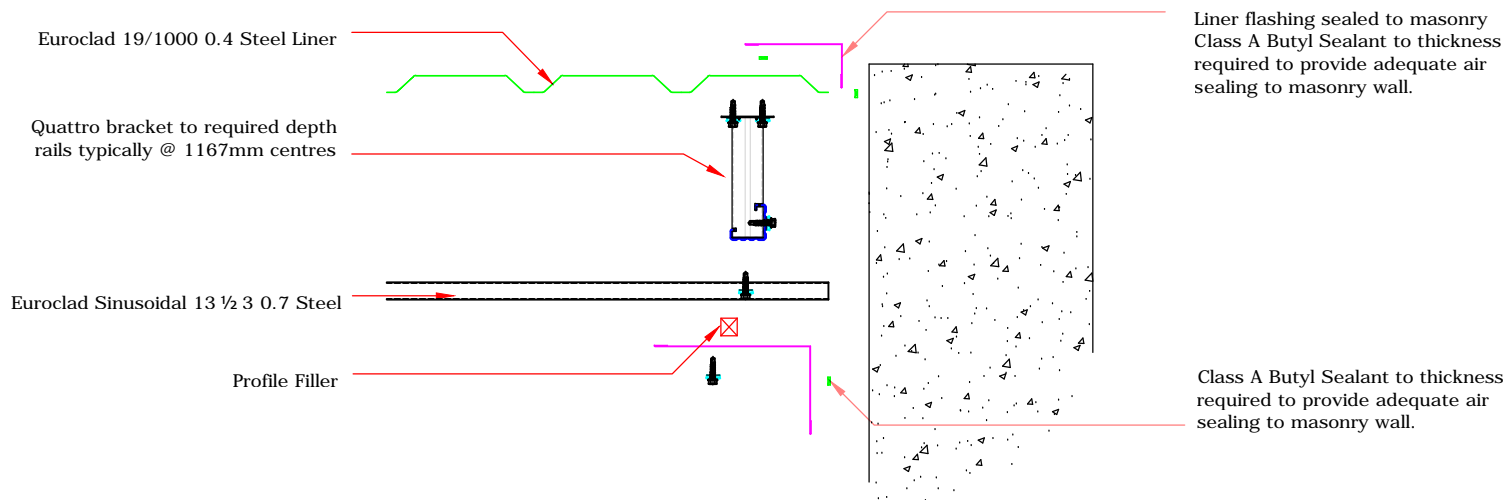

Insulation excluded for clarity  
 A range of mineral & glass wool insulations are available for different requirements

ELITE SYSTEMS



www.euroclad.com  
 Tel: +44 (0)2922 010 101  
 Fax: +44 (0)2922 010 122

TITLE: Elite System 57  
 DWG NO: E57  
 DRAWN: MP  
 CHECK: PCL  
 DATE: August 2015  
 SCALE: NTS

This draft drawing has been supplied by Euro Clad Ltd for the purpose of guidance free of charge. It is a suggested typical detail and as such should not be assumed suitable for any specific project or application. No responsibility is assumed for errors or misinterpretations resulting from the information contained in the drawing. Details are for illustration only and no liability is accepted. We reserve the right to change the details without notice. The drawing is copyright, it remains our property.

To be read in conjunction with Elite System specification documents

ELITE SYSTEMS



www.euroclad.com  
 Tel: +44 (0)2922 010 101  
 Fax: +44 (0)2922 010 122

TITLE: Elite System 57  
 DWG NO: E57  
 DRAWN: MP  
 CHECK: PCL  
 DATE: August 2015  
 SCALE: NTS

This draft drawing has been supplied by Euro Clad Ltd for the purpose of guidance free of charge. It is a suggested typical detail and as such should not be assumed suitable for any specific project or application. No responsibility is assumed for errors or misinterpretations resulting from the information contained in the drawing. Details are for illustration only and no liability is accepted. We reserve the right to change the details without notice. The drawing is copyright, it remains our property.

To be read in conjunction with Elite System specification documents

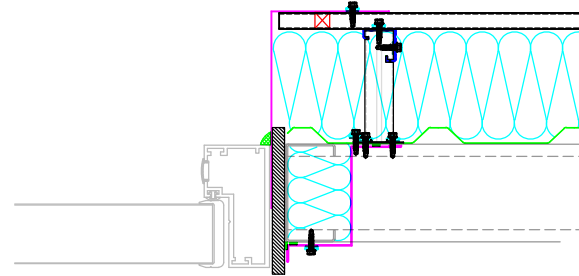

EUROCLAD ELITE SYSTEM 57 WALL CONSTRUCTION

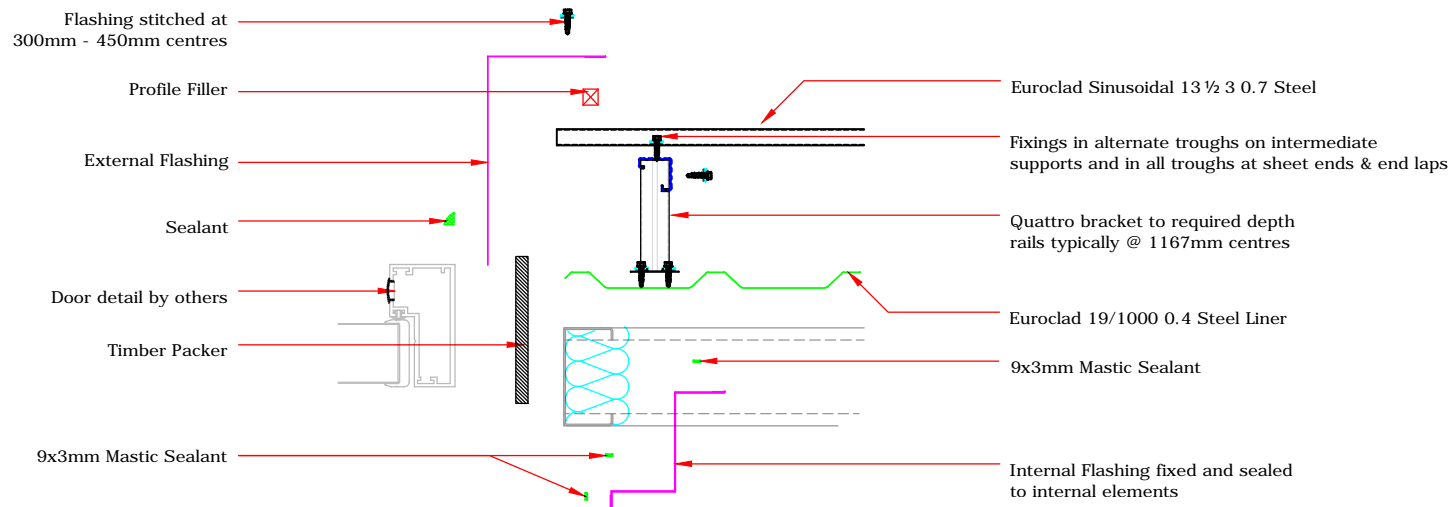

Insulation excluded for clarity  
 A range of mineral & glass wool insulations are available for different requirements

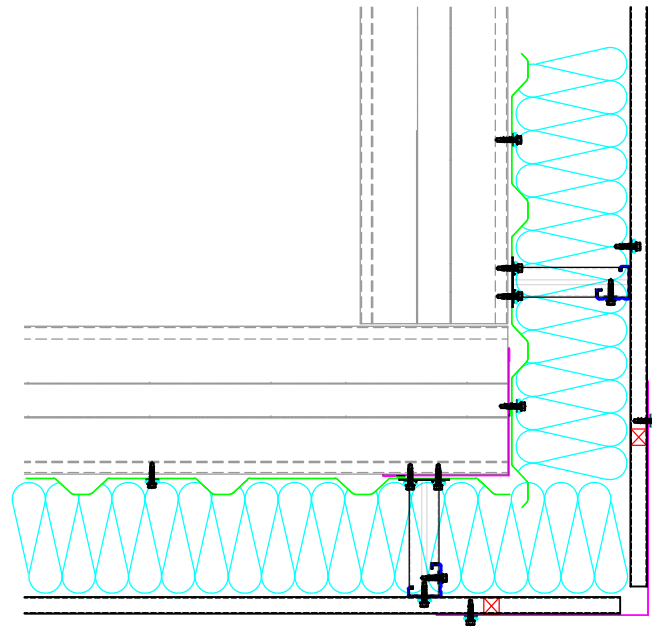

ELITE SYSTEMS



www.euroclad.com  
 Tel: +44 (0)2922 010 101  
 Fax: +44 (0)2922 010 122

TITLE: Elite System 57  
 DWG NO: E57  
 DRAWN: MP  
 CHECK: PCL  
 DATE: August 2015  
 SCALE: NTS

This draft drawing has been supplied by Euro Clad Ltd for the purpose of guidance free of charge. It is a suggested typical detail and as such should not be assumed suitable for any specific project or application. No responsibility is assumed for errors or misinterpretations resulting from the information contained in the drawing. Details are for illustration only and no liability is accepted. We reserve the right to change the details without notice. The drawing is copyright, it remains our property.

To be read in conjunction with Elite System specification documents

EUROCLAD ELITE SYSTEM 57 WALL CONSTRUCTION

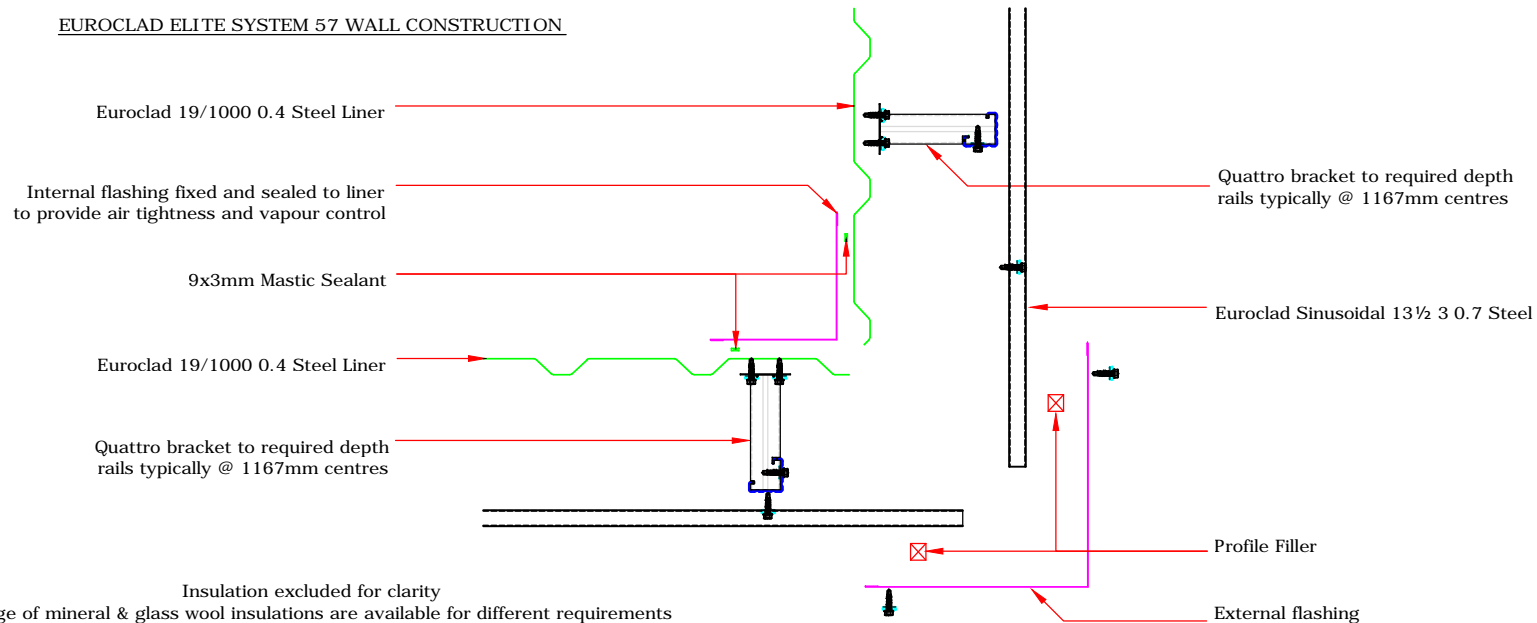

ELITE SYSTEMS



www.euroclad.com  
Tel: +44 (0)2922 010 101  
Fax: +44 (0)2922 010 122

TITLE: Elite System 57  
DWG NO: E57  
DRAWN: MP  
CHECK: PCL  
DATE: August 2015  
SCALE: NTS

This draft drawing has been supplied by Euro Clad Ltd for the purpose of guidance free of charge. It is a suggested typical detail and as such should not be assumed suitable for any specific project or application. No responsibility is assumed for errors or misinterpretations resulting from the information contained in the drawing. Details are for illustration only and no liability is accepted. We reserve the right to change the details without notice. The drawing is copyright, it remains our property.

To be read in conjunction with Elite System specification documents

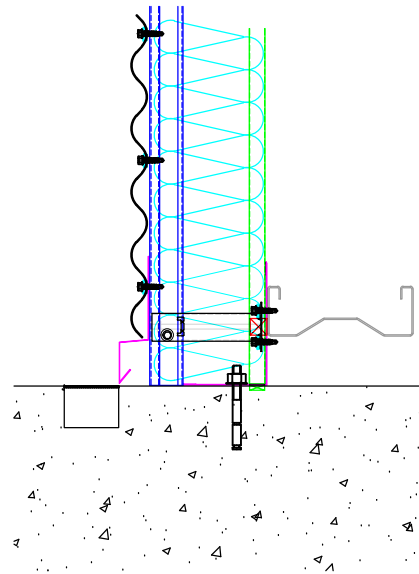

EUROCLAD ELITE SYSTEM 57 WALL CONSTRUCTION

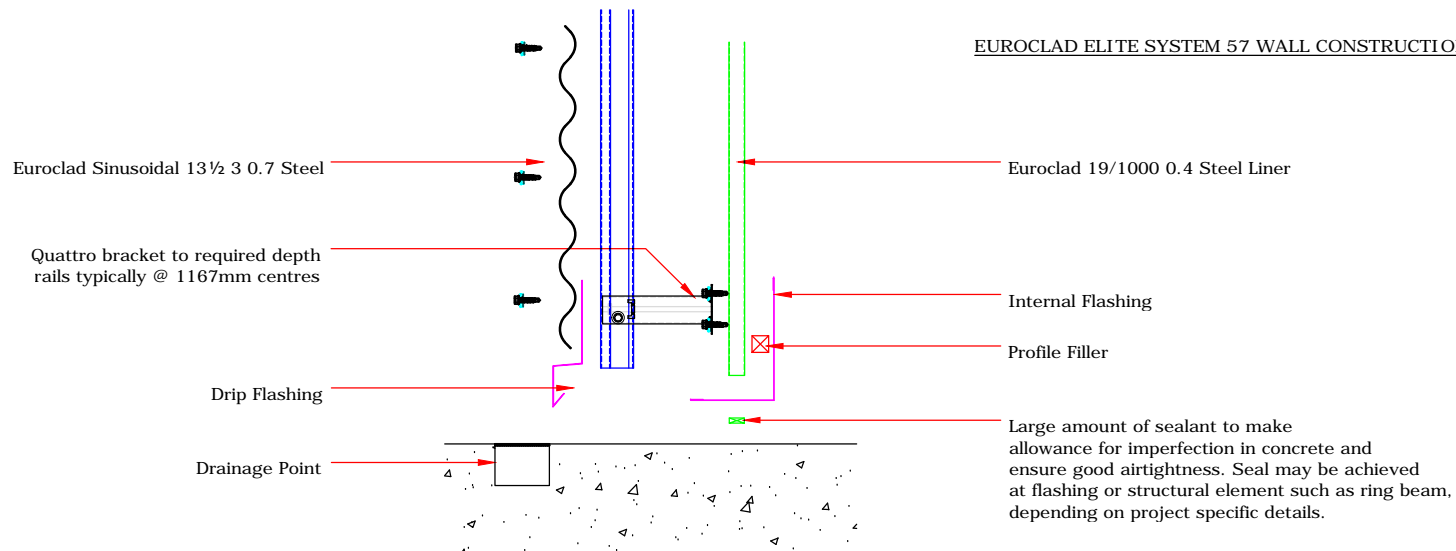

Insulation excluded for clarity  
A range of mineral & glass wool insulations are available for different requirements



ELITE SYSTEMS



www.euroclad.com  
 Tel: +44 (0)2922 010 101  
 Fax: +44 (0)2922 010 122

TITLE: Elite System 57  
 DWG NO: E57  
 DRAWN: MP  
 CHECK: PCL  
 DATE: August 2015  
 SCALE: NTS

This draft drawing has been supplied by Euro Clad Ltd for the purpose of guidance free of charge. It is a suggested typical detail and as such should not be assumed suitable for any specific project or application. No responsibility is assumed for errors or misinterpretations resulting from the information contained in the drawing. Details are for illustration only and no liability is accepted. We reserve the right to change the details without notice. The drawing is copyright, it remains our property.

To be read in conjunction with Elite System specification documents

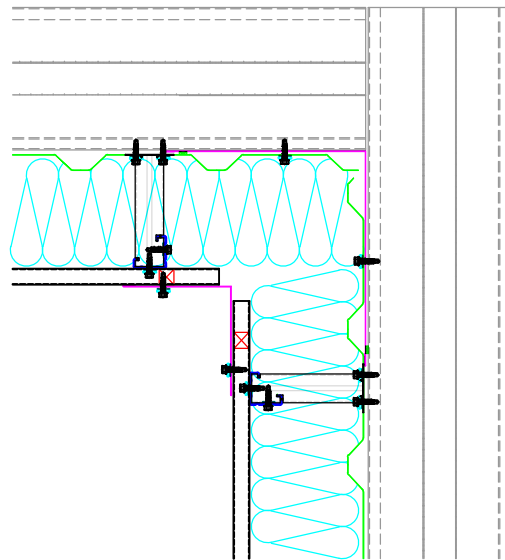

EUROCLAD ELITE SYSTEM 57 WALL CONSTRUCTION

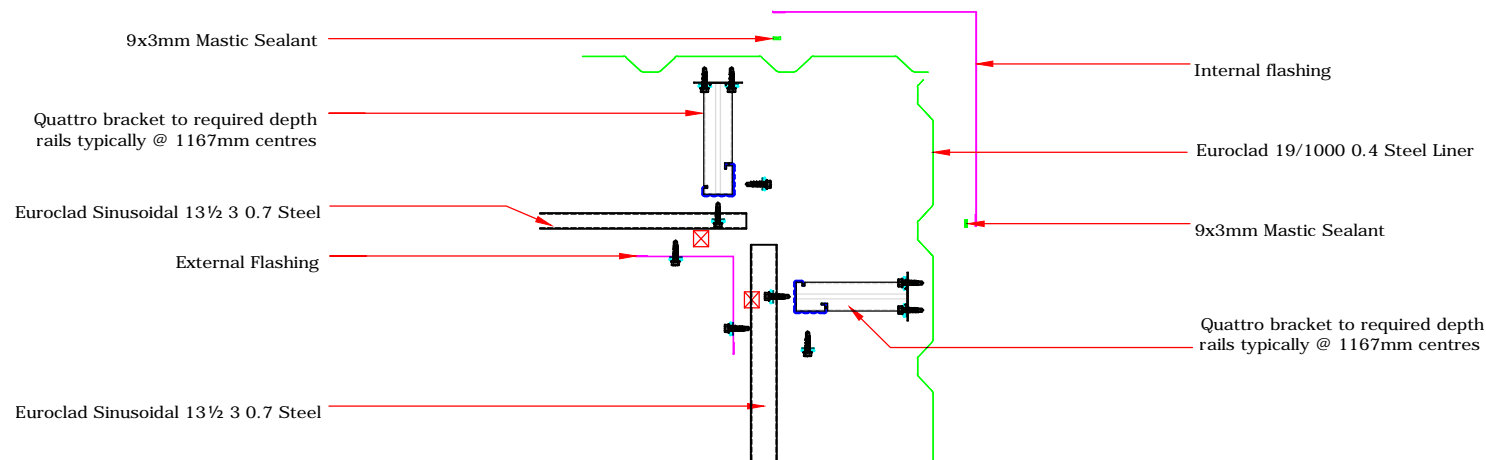

Insulation excluded for clarity  
 A range of mineral & glass wool insulations are available for different requirements

ELITE SYSTEMS



www.euroclad.com  
 Tel: +44 (0)2922 010 101  
 Fax: +44 (0)2922 010 122

TITLE: Elite System 57  
 DWG NO: E57  
 DRAWN: MP  
 CHECK: PCL  
 DATE: August 2015  
 SCALE: NTS

This draft drawing has been supplied by Euro Clad Ltd for the purpose of guidance free of charge. It is a suggested typical detail and as such should not be assumed suitable for any specific project or application. No responsibility is assumed for errors or misinterpretations resulting from the information contained in the drawing. Details are for illustration only and no liability is accepted. We reserve the right to change the details without notice. The drawing is copyright, it remains our property.

To be read in conjunction with Elite System specification documents

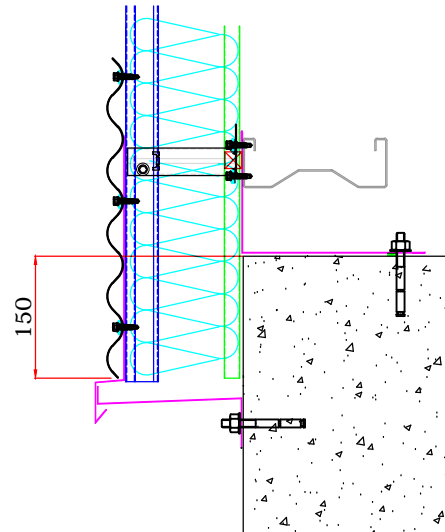

EUROCLAD ELITE SYSTEM 57 WALL CONSTRUCTION

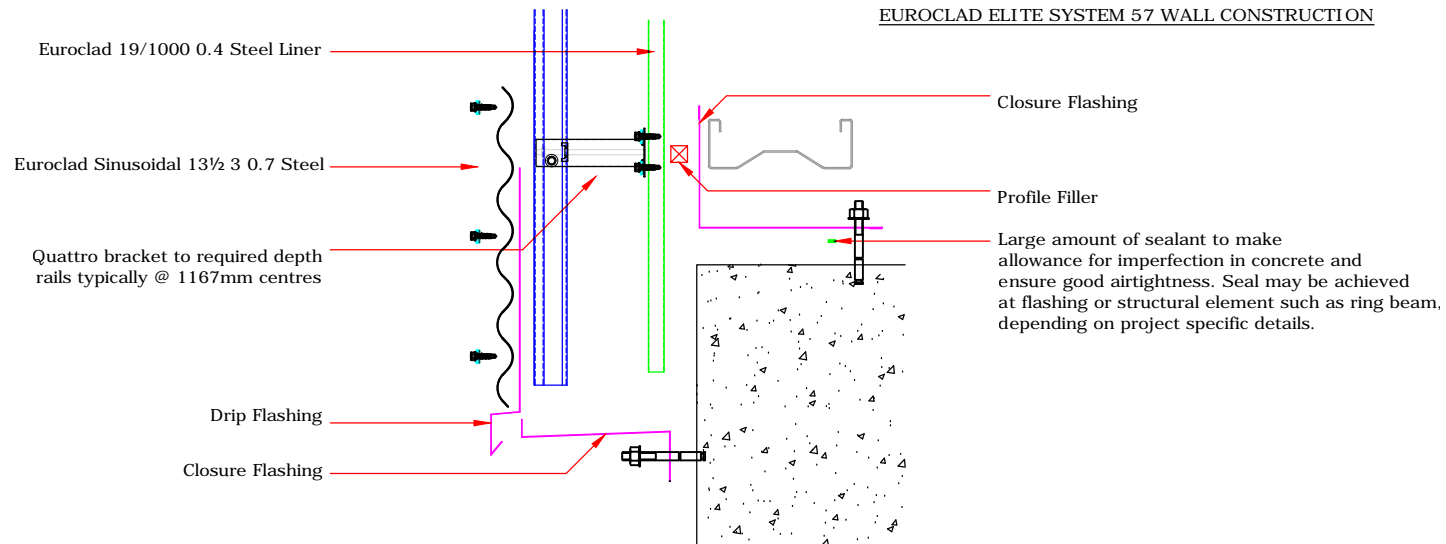

Insulation excluded for clarity  
 A range of mineral & glass wool insulations are available for different requirements

ELITE SYSTEMS



www.euroclad.com  
 Tel: +44 (0)2922 010 101  
 Fax: +44 (0)2922 010 122

TITLE: Elite System 57  
 DWG NO: E57  
 DRAWN: MP  
 CHECK: PCL  
 DATE: August 2015  
 SCALE: NTS

This draft drawing has been supplied by Euro Clad Ltd for the purpose of guidance free of charge. It is a suggested typical detail and as such should not be assumed suitable for any specific project or application. No responsibility is assumed for errors or misinterpretations resulting from the information contained in the drawing. Details are for illustration only and no liability is accepted. We reserve the right to change the details without notice. The drawing is copyright, it remains our property.

To be read in conjunction with Elite System specification documents

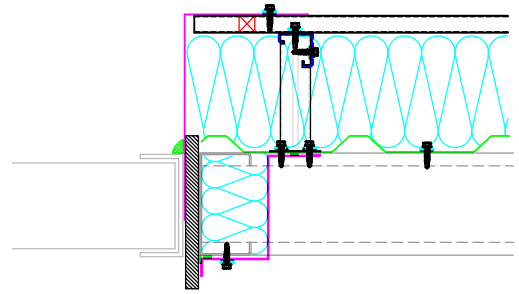

EUROCLAD ELITE SYSTEM 57 WALL CONSTRUCTION

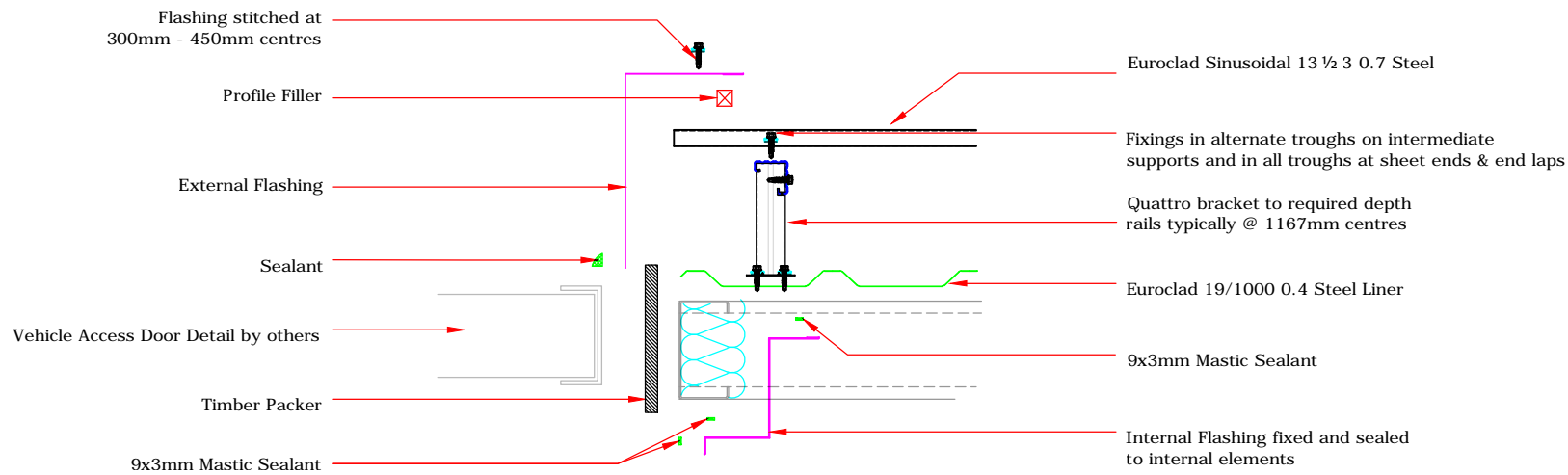

ELITE SYSTEMS



www.euroclad.com  
 Tel: +44 (0)2922 010 101  
 Fax: +44 (0)2922 010 122

TITLE: Elite System 57  
 DWG NO: E57  
 DRAWN: MP  
 CHECK: PCL  
 DATE: August 2015  
 SCALE: NTS

This draft drawing has been supplied by Euro Clad Ltd for the purpose of guidance free of charge. It is a suggested typical detail and as such should not be assumed suitable for any specific project or application. No responsibility is assumed for errors or misinterpretations resulting from the information contained in the drawing. Details are for illustration only and no liability is accepted. We reserve the right to change the details without notice. The drawing is copyright, it remains our property.

To be read in conjunction with Elite System specification documents

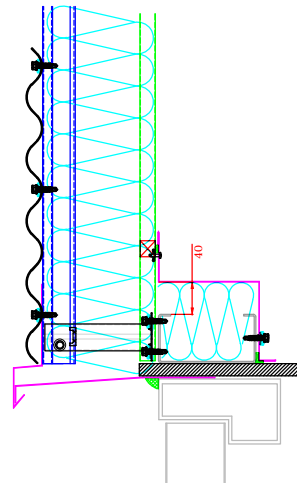

EUROCLAD ELITE SYSTEM 57 WALL CONSTRUCTION

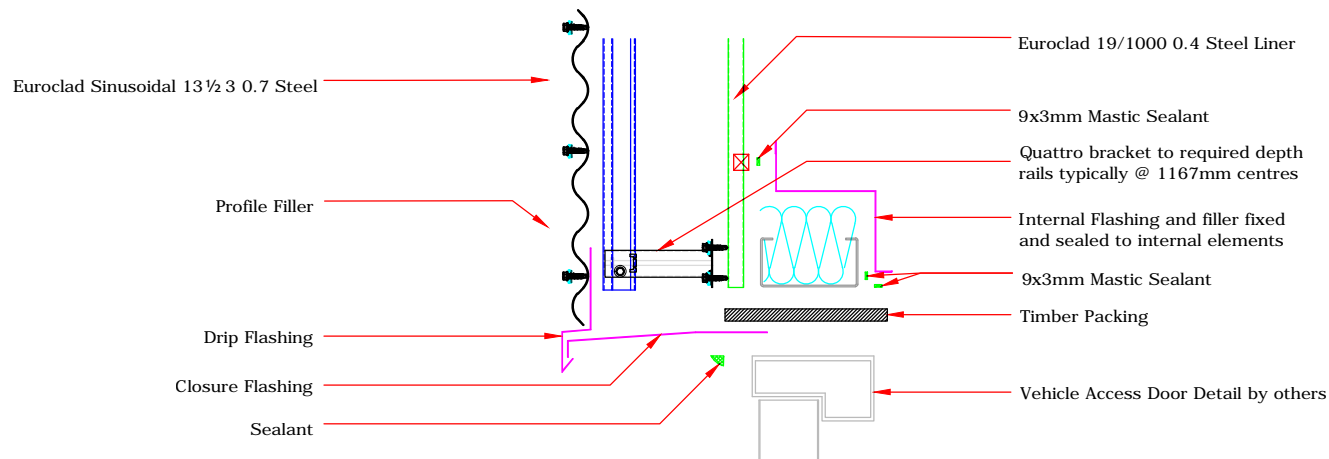

Insulation excluded for clarity  
 A range of mineral & glass wool insulations are available for different requirements

ELITE SYSTEMS



www.euroclad.com  
 Tel: +44 (0)2922 010 101  
 Fax: +44 (0)2922 010 122

TITLE: Elite System 57  
 DWG NO: E57  
 DRAWN: MP  
 CHECK: PCL  
 DATE: August 2015  
 SCALE: NTS

This draft drawing has been supplied by Euro Clad Ltd for the purpose of guidance free of charge. It is a suggested typical detail and as such should not be assumed suitable for any specific project or application. No responsibility is assumed for errors or misinterpretations resulting from the information contained in the drawing. Details are for illustration only and no liability is accepted. We reserve the right to change the details without notice. The drawing is copyright, it remains our property.

To be read in conjunction with Elite System specification documents

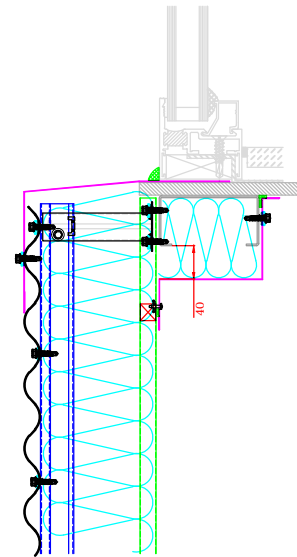

EUROCLAD ELITE SYSTEM 57 WALL CONSTRUCTION

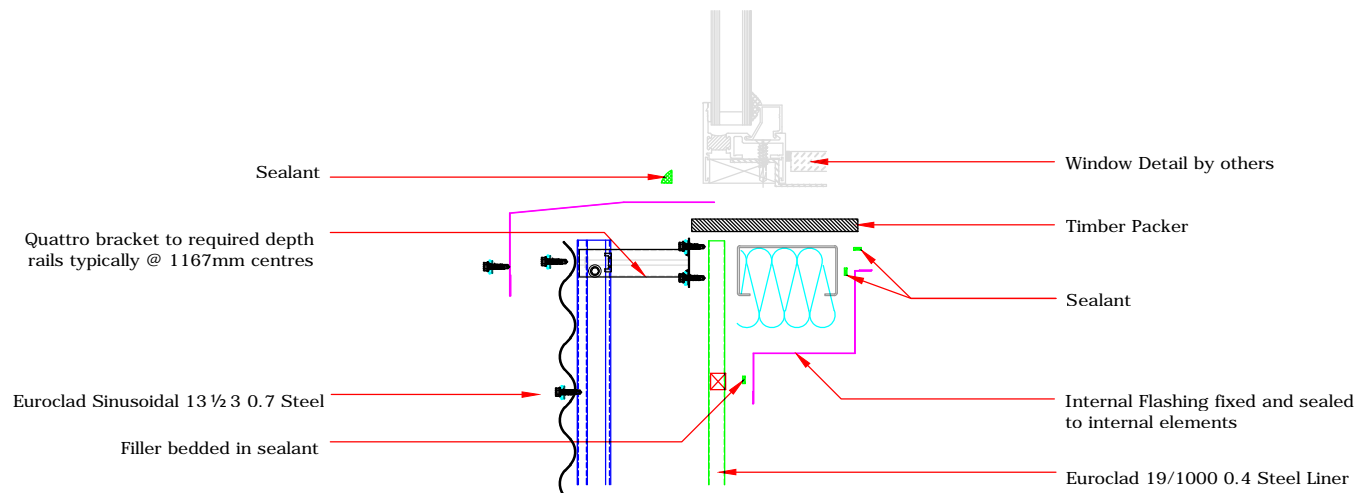

Insulation excluded for clarity  
 A range of mineral & glass wool insulations are available for different requirements

ELITE SYSTEMS



www.euroclad.com  
 Tel: +44 (0)2922 010 101  
 Fax: +44 (0)2922 010 122

TITLE: Elite System 57  
 DWG NO: E57  
 DRAWN: MP  
 CHECK: PCL  
 DATE: August 2015  
 SCALE: NTS

This draft drawing has been supplied by Euro Clad Ltd for the purpose of guidance free of charge. It is a suggested typical detail and as such should not be assumed suitable for any specific project or application. No responsibility is assumed for errors or misinterpretations resulting from the information contained in the drawing. Details are for illustration only and no liability is accepted. We reserve the right to change the details without notice. The drawing is copyright, it remains our property.

To be read in conjunction with Elite System specification documents

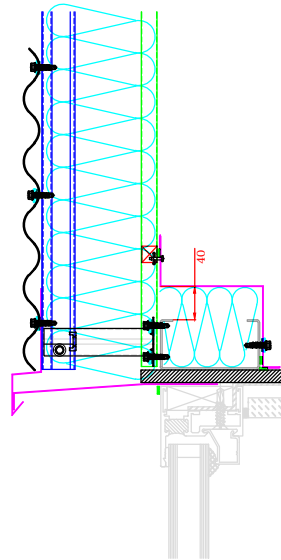

EUROCLAD ELITE SYSTEM 57 WALL CONSTRUCTION

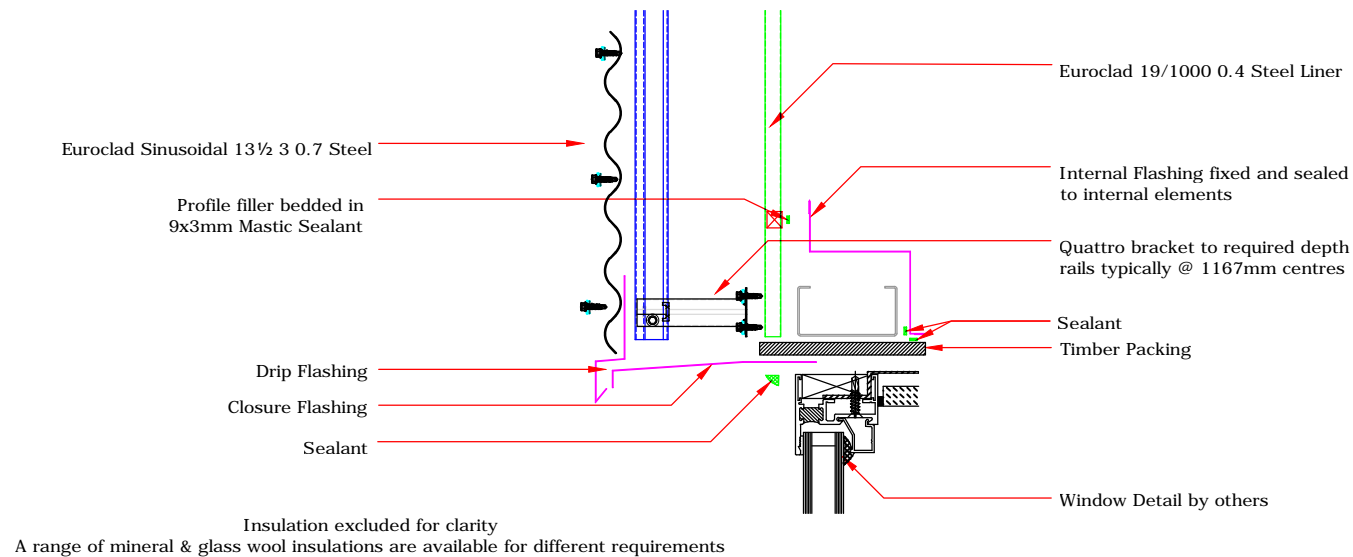

ELITE SYSTEMS



www.euroclad.com  
 Tel: +44 (0)2922 010 101  
 Fax: +44 (0)2922 010 122

TITLE: Elite System 57  
 DWG NO: E57  
 DRAWN: MP  
 CHECK: PCL  
 DATE: August 2015  
 SCALE: NTS

This draft drawing has been supplied by Euro Clad Ltd for the purpose of guidance free of charge. It is a suggested typical detail and as such should not be assumed suitable for any specific project or application. No responsibility is assumed for errors or misinterpretations resulting from the information contained in the drawing. Details are for illustration only and no liability is accepted. We reserve the right to change the details without notice. The drawing is copyright, it remains our property.

To be read in conjunction with Elite System specification documents

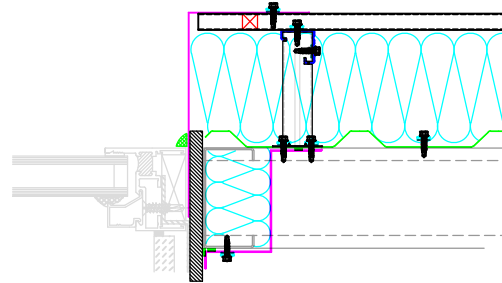

EUROCLAD ELITE SYSTEM 57 WALL CONSTRUCTION

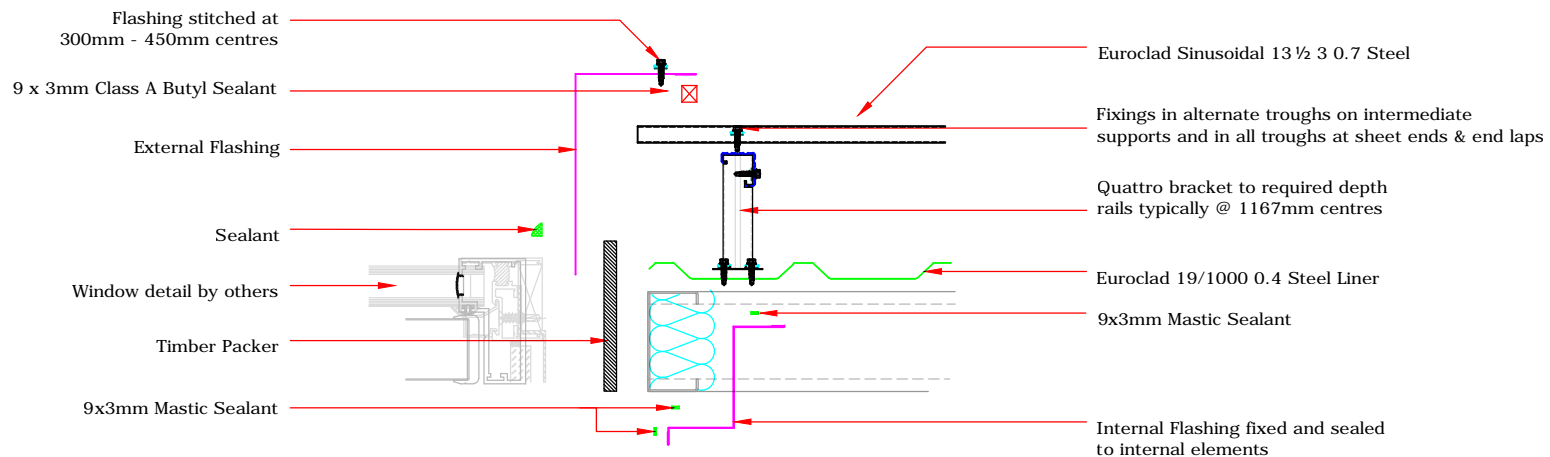

Insulation excluded for clarity  
 A range of mineral & glass wool insulations are available for different requirements